

Respuestas a ejercicios y evaluaciones impares

Capítulo 1

Sección 1.1 ■ página 10

1. a) 50 b) 0, -10, 50 c) 0, -10, 50, $\frac{22}{7}$, 0.538, 1.23, $-\frac{1}{3}$ d) $\sqrt{7}$, $\sqrt[3]{2}$

3. Propiedad conmutativa de la adición

5. Propiedad asociativa de la adición

7. Propiedad distributiva

9. Propiedad conmutativa de la multiplicación

11. $3 + x$ 13. $4A + 4B$ 15. $3x + 3y$ 17. $8m$

19. $-5x + 10y$ 21. a) $\frac{17}{30}$ b) $\frac{9}{20}$ 23. a) 3 b) $\frac{25}{72}$

25. a) $\frac{8}{3}$ b) 6 27. a) $<$ b) $>$ c) =

29. a) Falso b) Verdadero 31. a) Falso b) Verdadero

33. a) $x > 0$ b) $t < 4$ c) $a \geq \pi$ d) $-5 < x < \frac{1}{3}$

e) $|p - 3| \leq 5$ 35. a) {1, 2, 3, 4, 5, 6, 7, 8} b) {2, 4, 6}

37. a) {1, 2, 3, 4, 5, 6, 7, 8, 9, 10} b) {7}

39. a) $\{x | x \leq 5\}$ b) $\{x | -1 < x < 4\}$

41. $-3 < x < 0$



43. $2 \leq x < 8$



45. $x \geq 2$



47. $(-\infty, 1]$



49. $(-2, 1]$



51. $(-1, \infty)$

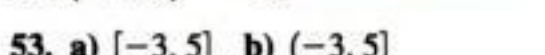

53. a) $[-3, 5]$ b) $(-3, 5]$

55. $[-2, 1]$



57. $[0, 6]$



59. $(-4, 4)$

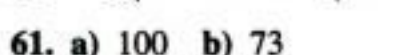

61. a) 100 b) 73

63. a) 2 b) -1 65. a) 12 b) 5 67. 5

69. a) 15 b) 24 c) $\frac{67}{40}$ 71. a) $\frac{7}{9}$ b) $\frac{13}{43}$ c) $\frac{19}{33}$

73. Propiedad distributiva

75. a) Sí, no b) 6 pies

Sección 1.2 ■ página 21

1. $5^{-1/2}$ 3. $\sqrt[3]{4^2}$ 5. $5^{3/5}$ 7. $\sqrt[5]{a^2}$ 9. a) -9 b) 9 c) 1

11. a) 4 b) $\frac{1}{81}$ c) 16 13. a) 4 b) 2 c) $\frac{1}{2}$

15. a) $\frac{2}{3}$ b) $-\frac{1}{4}$ c) $-\frac{1}{2}$ 17. a) $\frac{3}{2}$ b) 4 c) -4

19. 5 21. 14 23. $7\sqrt{2}$

25. $3\sqrt[5]{3}$ 27. a^4 29. $6x^7y^5$

31. $16x^{10}$ 33. $\frac{4}{b^2}$

35. $64r^7s$ 37. $648y^7$ 39. $\frac{x^3}{y}$

41. $\frac{y^2z^9}{x^5}$ 43. $\frac{s^3}{q^7r^6}$ 45. $|x|$

47. $2x^2$ 49. $|ab^3|$ 51. $2|x|$

53. $x^{13/15}$ 55. $\frac{-1}{9a^{5/4}}$

57. $16b^{9/10}$ 59. $\frac{1}{c^{2/3}d}$ 61. $y^{1/2}$

63. $\frac{32x^{12}}{y^{16/15}}$ 65. $\frac{x^{15}}{y^{15/2}}$ 67. $\frac{4a^2}{3b^{1/3}}$ 69. $\frac{3t^{25/6}}{s^{1/2}}$

71. a) 6.93×10^7 b) 7.2×10^{12} c) 2.8536×10^{-5}

d) 1.213×10^{-4} 73. a) 319 000 b) 272 100 000

c) 0.00000002670 d) 0.000000009999

75. a) 5.9×10^{12} millas b) 4×10^{-13} cm

c) 3.3×10^{19} moléculas 77. 1.3×10^{-20}

79. 1.429×10^{19} 81. 7.4×10^{-14}

83. a) $\frac{\sqrt{10}}{10}$ b) $\frac{\sqrt{2x}}{x}$ c) $\frac{\sqrt{3x}}{3}$

85. a) $\frac{2\sqrt[3]{x^2}}{x}$ b) $\frac{\sqrt[4]{y}}{y}$ c) $\frac{xy^{3/5}}{y}$

87. a) Negativo b) Positivo c) Negativo d) Negativo
 e) Positivo f) Negativo 89. 2.5×10^{13} millas
 91. 1.3×10^{21} L 93. 4.03×10^{27} moléculas
 95. a) 28 millas/h b) 167 pies 97. a) 17.707 pies/s
 b) 1328.0 pies³/s

Sección 1.3 ■ página 31

1. Trinomio; $x^2, -3x, 7; 2$ 3. Monomio; $-8; 0$
 5. Cuatro términos; $-x^4, x^3, -x^2, x; 4$ 7. $7x + 5$
 9. $5x^2 - 2x - 4$ 11. $x^3 + 3x^2 - 6x + 11$
 13. $9x + 103$ 15. $-t^4 + t^3 - t^2 - 10t + 5$
 17. $x^{3/2} - x$ 19. $21t^2 - 29t + 10$ 21. $3x^2 + 5xy - 2y^2$
 23. $1 - 4y + 4y^2$ 25. $4x^4 + 12x^2y^2 + 9y^4$
 27. $2x^3 - 7x^2 + 7x - 5$ 29. $x^4 - a^4$ 31. $a - 1/b^2$
 33. $1 + 3a^3 + 3a^6 + a^9$ 35. $2x^4 + x^3 - x^2 + 3x - 2$
 37. $1 - x^{2/3} + x^{4/3} - x^2$ 39. $3x^4y^4 + 7x^3y^5 - 6x^2y^3 - 14xy^4$
 41. $x^2 - y^2 - 2yz - z^2$ 43. $2x(-x^2 + 8)$
 45. $(y - 6)(y + 9)$ 47. $xy(2x - 6y + 3)$
 49. $(x - 1)(x + 3)$ 51. $(2x - 5)(4x + 3)$
 53. $(3x + 4)(3x + 8)$ 55. $(3a - 4)(3a + 4)$
 57. $(3x + y)(9x^2 - 3xy + y^2)$ 59. $(x + 6)^2$
 61. $(x + 4)(x^2 + 1)$ 63. $(2x + 1)(x^2 - 3)$
 65. $(x + 1)(x^2 + 1)$ 67. $x^{1/2}(x + 1)(x - 1)$
 69. $(x^2 + 3)(x^2 + 1)^{-1/2}$ 71. $6x(2x^2 + 3)$
 73. $(x - 4)(x + 2)$ 75. $(2x + 3)(x + 1)$
 77. $(3x + 2)(2x - 3)$ 79. $(5s - t)^2$
 81. $(2x - 5)(2x + 5)$ 83. $4ab$
 85. $(x + 3)(x - 3)(x + 1)(x - 1)$
 87. $(2x + 5)(4x^2 - 10x + 25)$
 89. $(x^2 - 2y)(x^4 + 2x^2y + 4y^2)$ 91. $x(x + 1)^2$
 93. $(y + 2)(y - 2)(y - 3)$ 95. $(2x^2 + 1)(x + 2)$
 97. $3(x - 1)(x + 2)$ 99. $(a + 2)(a - 2)(a + 1)(a - 1)$
 101. $2(x^2 + 4)^4(x - 2)^3(7x^2 - 10x + 8)$
 103. $(x^2 + 3)^{-4/3}(\frac{1}{3}x^2 + 3)$
 105. d) $(a + b + c)(a + b - c)(a - b + c)(b - a + c)$

Sección 1.4 ■ página 41

1. \mathbb{R} 3. $x \neq 4$ 5. $x \geq -3$ 7. $\frac{x + 2}{2(x - 1)}$ 9. $\frac{1}{x + 2}$
 11. $\frac{x + 2}{x + 1}$ 13. $\frac{y}{y - 1}$ 15. $\frac{x(2x + 3)}{2x - 3}$ 17. $\frac{1}{4(x - 2)}$
 19. $\frac{x + 3}{3 - x}$ 21. $\frac{1}{t^2 + 9}$ 23. $\frac{x + 4}{x + 1}$ 25. $\frac{(2x + 1)(2x - 1)}{(x + 5)^2}$
 27. $x^2(x + 1)$ 29. $\frac{x}{yz}$ 31. $\frac{3(x + 2)}{x + 3}$ 33. $\frac{3x + 7}{(x - 3)(x + 5)}$
 35. $\frac{1}{(x + 1)(x + 2)}$ 37. $\frac{3x + 2}{(x + 1)^2}$ 39. $\frac{u^2 + 3u + 1}{u + 1}$
 41. $\frac{2x + 1}{x^2(x + 1)}$ 43. $\frac{2x + 7}{(x + 3)(x + 4)}$ 45. $\frac{x - 2}{(x + 3)(x - 3)}$

47. $\frac{5x - 6}{x(x - 1)}$ 49. $\frac{-5}{(x + 1)(x + 2)(x - 3)}$ 51. $-xy$
 53. $\frac{c}{c - 2}$ 55. $\frac{3x + 7}{x^2 + 2x - 1}$ 57. $\frac{y - x}{xy}$
 59. 1 61. $\frac{-1}{a(a + h)}$ 63. $\frac{-3}{(2 + x)(2 + x + h)}$
 65. $\frac{1}{\sqrt{1 - x^2}}$ 67. $\frac{(x + 2)^2(x - 13)}{(x - 3)^3}$ 69. $\frac{x + 2}{(x + 1)^{3/2}}$
 71. $\frac{2x + 3}{(x + 1)^{4/3}}$ 73. $2 + \sqrt{3}$ 75. $\frac{2(\sqrt{7} - \sqrt{2})}{5}$
 77. $\frac{y\sqrt{3} - y\sqrt{y}}{3 - y}$ 79. $\frac{-4}{3(1 + \sqrt{5})}$ 81. $\frac{r - 2}{5(\sqrt{r} - \sqrt{2})}$
 83. $\frac{1}{\sqrt{x^2 + 1} + x}$ 85. Verdadero 87. Falso 89. Falso
 91. Verdadero 93. a) $\frac{R_1R_2}{R_1 + R_2}$ b) $\frac{20}{3} \approx 6.7$ ohms

Sección 1.5 ■ página 55

1. a) No b) Sí 3. a) Sí b) No 5. 12 7. 18
 9. -3 11. 12 13. $-\frac{3}{4}$ 15. 30 17. $-\frac{1}{3}$ 19. $\frac{13}{3}$
 21. -2 23. $R = \frac{PV}{nT}$ 25. $R_1 = \frac{RR_2}{R_2 - R}$ 27. $x = \frac{2d - b}{a - 2c}$
 29. $x = \frac{1 - a}{a^2 - a - 1}$ 31. $r = \pm \sqrt{\frac{3V}{\pi h}}$
 33. $b = \pm \sqrt{c^2 - a^2}$ 35. $t = \frac{-v_0 \pm \sqrt{v_0^2 + 2gh}}{g}$
 37. -4, 3 39. 3, 4 41. $-\frac{3}{2}, \frac{5}{2}$ 43. $-2, \frac{1}{3}$ 45. $-1 \pm \sqrt{6}$
 47. $-\frac{7}{2}, \frac{1}{2}$ 49. $-2 \pm \frac{\sqrt{14}}{2}$ 51. $0, \frac{1}{4}$ 53. -3, 5
 55. $\frac{-3 \pm \sqrt{5}}{2}$ 57. $-\frac{3}{2}, 1$ 59. $\frac{1 \pm \sqrt{5}}{4}$ 61. $-\frac{9}{2}, \frac{1}{2}$
 63. $\frac{-5 \pm \sqrt{13}}{2}$ 65. $-\frac{\sqrt{6}}{2}, \frac{\sqrt{6}}{6}$ 67. $-\frac{7}{3}$ 69. 2 71. 1
 73. No hay solución real 75. $-\frac{7}{3}, 2$ 77. -50, 100 79. -4
 81. 4 83. 3 85. $\pm 2\sqrt{2}, \pm \sqrt{5}$ 87. No hay solución real
 89. $\pm 3\sqrt{3}, \pm 2\sqrt{2}$ 91. -1, 0, 3 93. 27, 729 95. $-\frac{3}{2}, \frac{3}{2}$
 97. 3.99, 4.01 99. 4.24 s 101. a) Después de 1 s y $1\frac{1}{2}$ s
 b) Nunca c) 25 pies d) Después $1\frac{1}{4}$ s e) Después $2\frac{1}{2}$ s
 103. a) 0.00055, 12.018 m b) 234.375 kg/m³
 105. a) Después de 17 años, el 1 de enero de 2019;
 b) Después de 18.612 años, el 12 de agosto de 2020;
 107. 50 109. 132.6 pies

Sección 1.6 ■ página 68

1. $3n + 3$ 3. $\frac{160 + s}{3}$ 5. $0.025x$ 7. $A = 3w^2$
 9. $d = \frac{3}{4}s$ 11. $\frac{25}{x + 3}$ 13. 51, 52, 53 15. 19 y 36

17. \$9000 dólares a $4\frac{1}{2}\%$ y \$3000 dólares a 4% 19. 7.5%
 21. \$7400 23. \$45 000 25. Plomero, 70 h; ayudante, 35 h
 27. 40 años de edad 29. 9 centavos, 9 de a cinco centavos,
 9 de a 10 centavos 31. 6.4 pies desde el punto de apoyo
 33. a) 9 cm b) 5 pulg 35. 45 pies 37. 120 pies por lado
 39. 25 por 35 pies 41. 60 por 40 pies 43. 120 pies
 45. 4 pulg 47. 18 pies 49. 5 m 51. 4 53. 18 g
 55. 0.6 L 57. 35% 59. 37 min 20 s 61. 3 h
 63. Irene 3 h, Henry $4\frac{1}{2}$ h 65. 4 h 67. 500 millas/h
 69. 50 millas/h (o 240 millas/h) 71. 6 km/h
 73. 2 por 6 por 15 pies 75. 13 por 13 pulg 77. 2.88 pies
 79. 16 millas; no 81. 7.52 pies 83. 18 pies 85. 4.55 pies

Sección 1.7 ■ página 84

1. $\{\sqrt{2}, 2, 4\}$ 3. $\{4\}$

5. $\{-2, -1, 2, 4\}$

7. $(4, \infty)$



11. $(-\infty, -\frac{1}{2})$



15. $(\frac{16}{3}, \infty)$



19. $(-\infty, -1]$

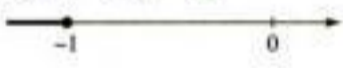

23. $(2, 6)$



27. $(\frac{15}{2}, \frac{21}{2}]$



31. $(-\infty, -\frac{7}{2}] \cup [0, \infty)$



35. $(-\infty, -1] \cup [\frac{1}{2}, \infty)$



39. $(-\infty, -3) \cup (6, \infty)$



43. $(-\infty, \infty)$

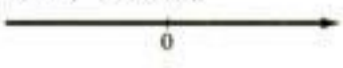

47. $(-\infty, -1) \cup [3, \infty)$



9. $(-\infty, 2]$



13. $[1, \infty)$



17. $(-\infty, -18)$



21. $[-3, -1)$



25. $[\frac{9}{2}, 5)$



29. $(-2, 3)$



33. $[-3, 6]$



37. $(-1, 4)$



41. $(-2, 2)$



45. $(-2, 0) \cup (2, \infty)$

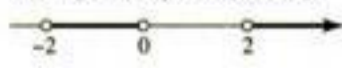

49. $(-\infty, -\frac{3}{2})$



51. $(-\infty, 5) \cup [16, \infty)$



55. $[-2, -1) \cup (0, 1]$



59. $(-3, -\frac{1}{2}) \cup (2, \infty)$



63. $[-4, 4]$



67. $[2, 8]$



71. $(-4, 8)$



75. $[-\frac{1}{2}, \frac{3}{2}]$



77. $|x| < 3$ 79. $|x - 7| \geq 5$ 81. $|x| \leq 2$

83. $|x| > 3$ 85. $|x - 1| \leq 3$ 87. $-\frac{4}{3} \leq x \leq \frac{4}{3}$

89. $x < -2$ o $x > 7$ 91. a) $x \geq \frac{c}{a} + \frac{c}{b}$

b) $\frac{a - c}{b} \leq x < \frac{2a - c}{b}$

93. $68 \leq F \leq 86$ 95. Más de 200 millas 97. Entre 12 000 y 14 000 millas 99. Distancias entre 20 000 y 100 000 km

101. Entre 0 y 60 millas/h 103. a) $T = 20 - \frac{h}{100}$

b) Desde 20°C pasa a -30°C 105. 24

107. a) $|x - 0.020| \leq 0.003$ b) $0.017 \leq x \leq 0.023$

Sección 1.8 ■ página 97

1.

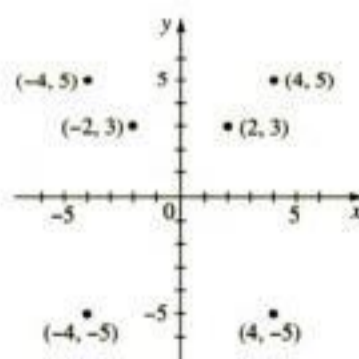

3. a) $\sqrt{13}$ b) $(\frac{3}{2}, 1)$ 5. a) 10 b) $(1, 0)$

7. a)

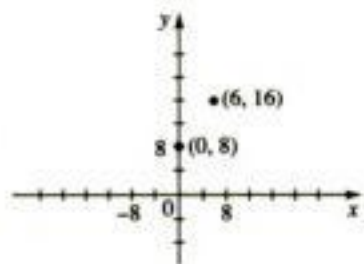

b) 10 c) (3, 12)

11. a)

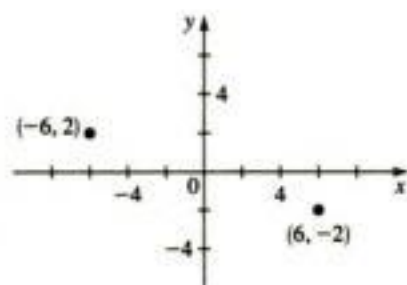

b) $4\sqrt{10}$ c) (0, 0)

15. Trapezoide, área = 9

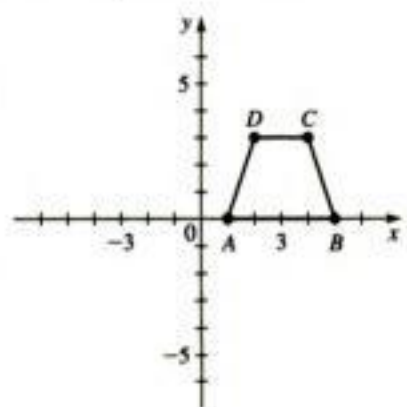

19.

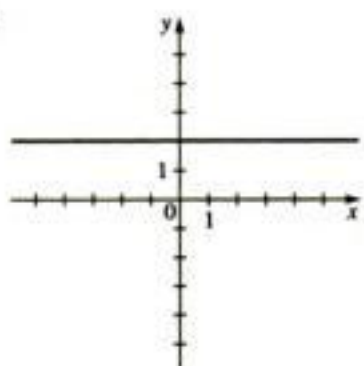

23.

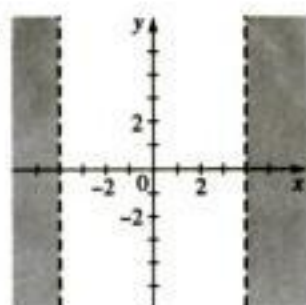

27. A(6, 7) 29. Q(-1, 3) 33. b) 10 37. (0, -4)

9. a)

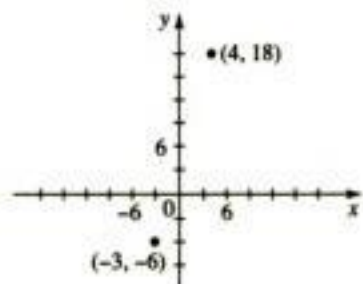

b) 25 c) $(\frac{1}{2}, 6)$

13. 24

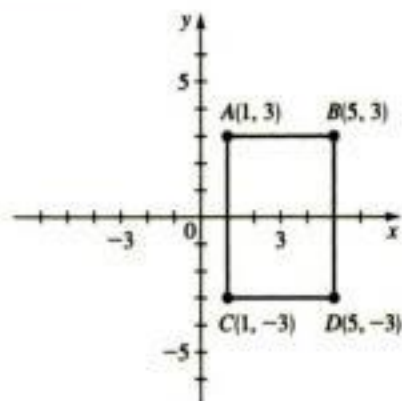

17.

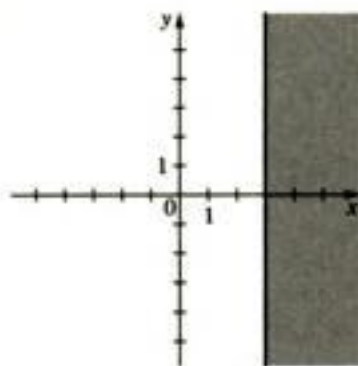

21.

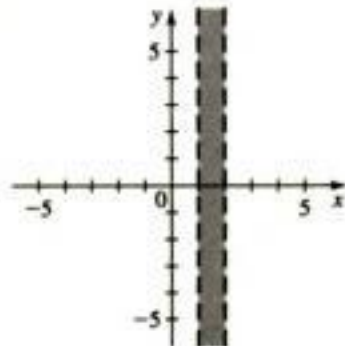

25.

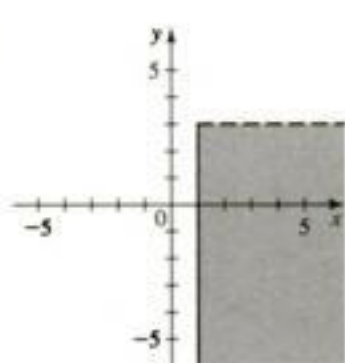

39. (2, -3)

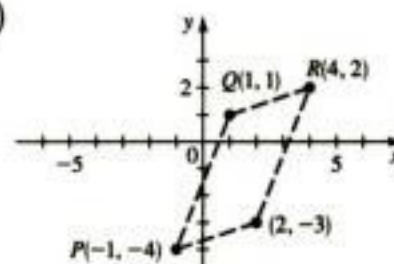

41. a)

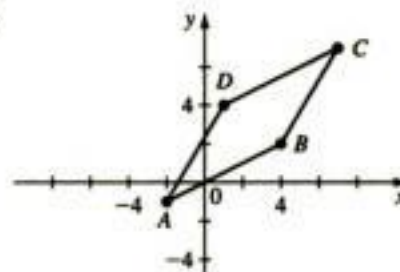

b) $(\frac{5}{2}, 3), (\frac{5}{2}, 3)$

43. No, sí, sí 45. Sí, no, sí

47. intersección con x en 0, 4; intersección con y en 0

49. corta a x en -2, 2; corta a y en -4, 4

51. Corta al eje x en 4, ordenada al origen = 4, sin simetría

53. Corta al eje x en 3, ordenada al origen = -6, sin simetría

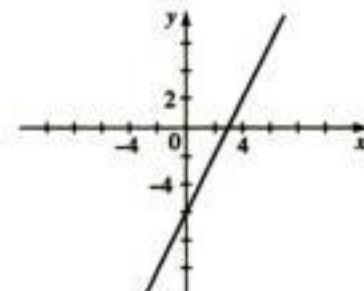
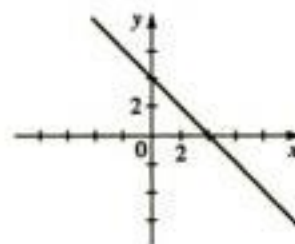

55. Corta al eje x en ± 1 , intersección con y en 1, simétrica con respecto a y

57. Pasa por x = 0, y = 0, simétrica con respecto a y

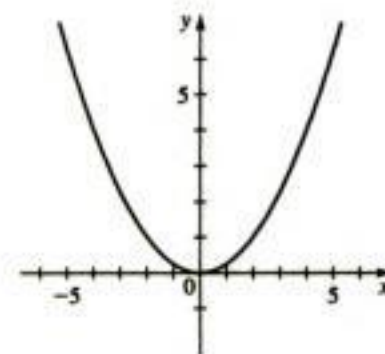
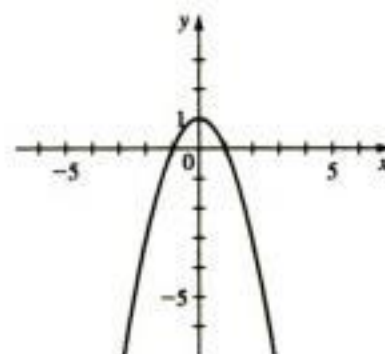

59. Corta al eje x en ± 3 , corta a y en -9, simétrica con respecto al eje y

61. Sin intersecciones, simétrica con respecto al origen

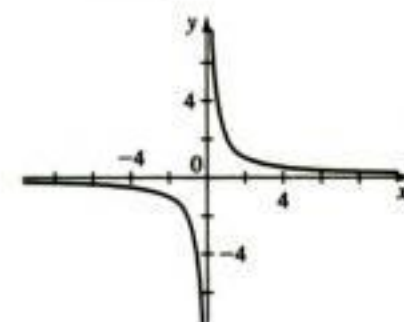
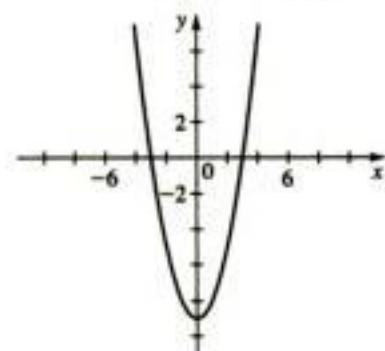

Sección 1.10 ■ página 120

1. $\frac{1}{2}$ 3. $\frac{1}{6}$ 5. $-\frac{1}{2}$ 7. $-\frac{9}{2}$ 9. $-2, \frac{1}{2}, 3, -\frac{1}{4}$
 11. $x + y - 4 = 0$
 13. $3x - 2y - 6 = 0$
 15. $x - y + 1 = 0$
 17. $2x - 3y + 19 = 0$
 19. $5x + y - 11 = 0$
 21. $3x - y - 2 = 0$
 23. $3x - y - 3 = 0$
 25. $y = 5$ 27. $x + 2y + 11 = 0$
 29. $x = -1$
 31. $5x - 2y + 1 = 0$
 33. $x - y + 6 = 0$
 35. a)

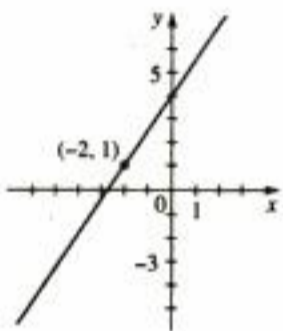

37. Todas tienen la misma pendiente.

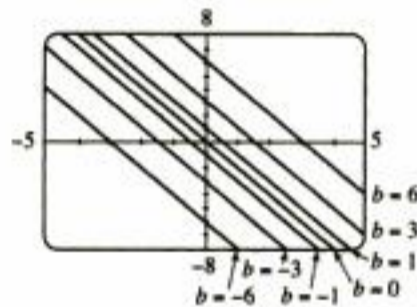

- b) $3x - 2y + 8 = 0$
 39. Todas cortan al eje x en el mismo punto

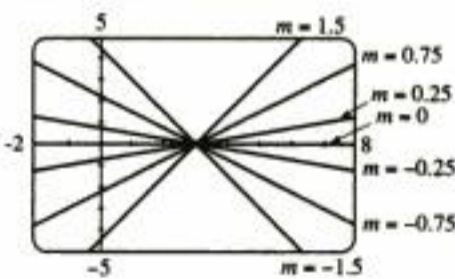

41. $-1, 3$

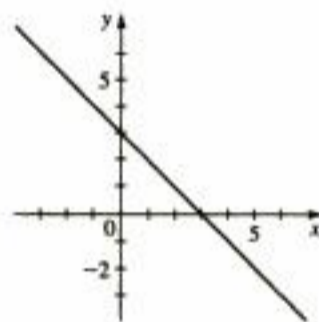

51. $-\frac{3}{4}, \frac{1}{4}$

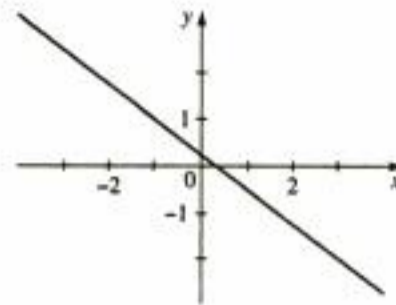

57. $x - y - 3 = 0$ 59. b) $4x - 3y - 24 = 0$
 61. 16 667 pies 63. a) 8.34; la pendiente representa el incremento en la dosis para un aumento de un año en la edad. b) 8.34 mg

65. a)

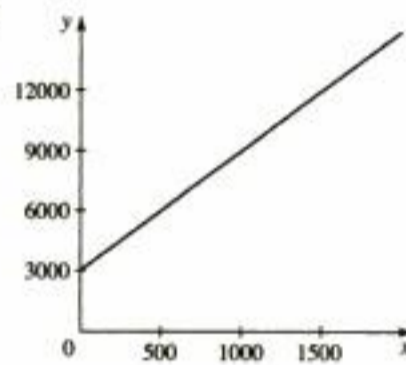

b) La pendiente representa el costo de producción por tostador; el corte con el eje y representa el costo fijo mensual.

67. a) $t = \frac{5}{24}n + 45$ b) 76°F

69. a) $P = 0.434d + 15$, donde P es la presión en lb/pulg² y d es la profundidad en pies

b)

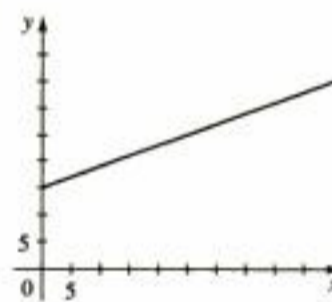

c) La pendiente es la rapidez de incremento en la presión del agua, y la ordenada al origen es la presión del aire en la superficie d) 196 pies

43. $-\frac{1}{3}, 0$

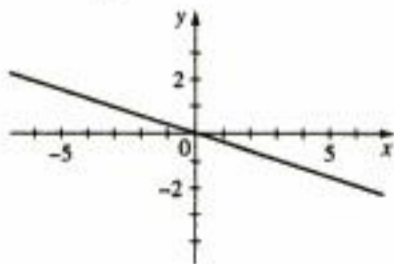

45. $\frac{3}{2}, 3$

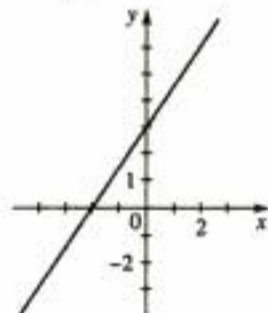

71. a) $C = \frac{1}{4}d + 260$

b) \$635

c) La pendiente representa el costo por milla

d) La ordenada al origen representa el costo fijo mensual

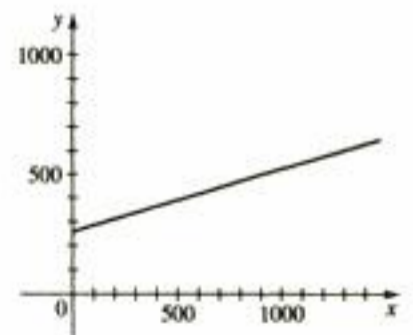

47. 0, 4

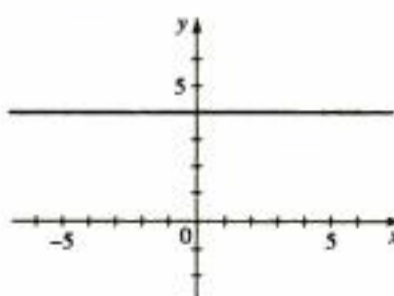

49. $\frac{3}{4}, -3$

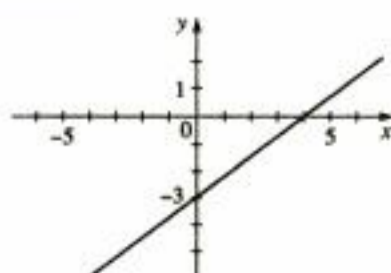

Sección 1.11 ■ página 127

1. $T = kx$ 3. $v = k/z$ 5. $y = ks/t$ 7. $z = k\sqrt{y}$
 9. $V = klwh$ 11. $R = k\frac{i}{Pt}$ 13. $y = 7x$ 15. $M = 15x/y$
 17. $W = 360/r^2$ 19. $C = 16lwh$ 21. $s = 500/\sqrt{t}$
 23. a) $F = kx$ b) 8 c) 32 N 25. a) $C = kpm$

- b) 0.125 c) \$57 500 27. a) $P = ks^3$ b) 0.012
 c) 324 29. 0.7 dB 31. 4 33. 5.3 millas/h
 35. a) $R = kL/d^2$ b) 0.002916 c) $R \approx 137 \Omega$
 37. a) 160 000 b) 1930 670 340 39. 36 lb
 41. a) $f = k/L$ b) Se divide a la mitad

Capítulo 1 Repaso ■ página 131

1. Propiedad conmutativa de la adición
 3. Propiedad distributiva

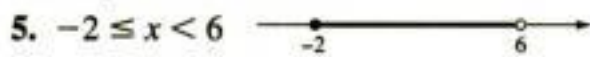

9. 6 11. $\frac{1}{2}$ 13. $\frac{1}{6}$ 15. 11 17. 4 19. $16x^3$

21. $12xy^8$ 23. x^2y^2 25. $3x^{3/2}y^2$ 27. $\frac{4r^{5/2}}{s^7}$

29. 7.825×10^{10} 31. 1.65×10^{-32}

33. $3xy^2(4xy^2 - y^3 + 3x^2)$ 35. $(x - 2)(x + 5)$

37. $(4t + 3)(t - 4)$ 39. $(5 - 4t)(5 + 4t)$

41. $(x - 1)(x^2 + x + 1)(x + 1)(x^2 - x + 1)$

43. $x^{-1/2}(x - 1)^2$ 45. $(x - 2)(4x^2 + 3)$

47. $\sqrt{x^2 + 2}(x^2 + x + 2)^2$ 49. $6x^2 - 21x + 3$

51. $-7 + x$ 53. $2x^3 - 6x^2 + 4x$ 55. $\frac{3(x + 3)}{x + 4}$ 57. $\frac{x + 1}{x - 4}$

59. $\frac{1}{x + 1}$ 61. $-\frac{1}{2x}$ 63. $3\sqrt{2} - 2\sqrt{3}$

65. 5 67. No hay solución 69. 2, 7 71. $-1, \frac{1}{2}$

73. $0, \pm \frac{5}{2}$ 75. $\frac{-2 \pm \sqrt{7}}{3}$ 77. -5 79. 3, 11

81. 20 lb de pasitas, 30 lb de nueces

83. $\frac{1}{4}(\sqrt{329} - 3) \approx 3.78$ millas/h 85. 1 h 50 min

87. $(-3, \infty)$ 89. $(-\infty, -6) \cup (2, \infty)$



91. $(-\infty, -2) \cup (2, 4]$

93. $[2, 8]$



95. -1, 7 97. $[1, 3]$

99. a)

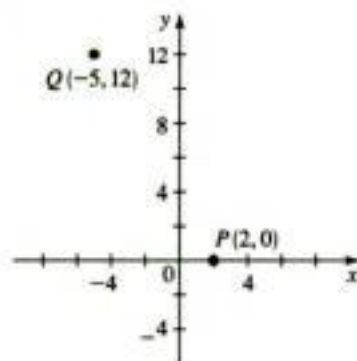

- b) $\sqrt{193}$

- c) $(-\frac{3}{2}, 6)$

d) $y = -\frac{12}{7}x + \frac{24}{7}$

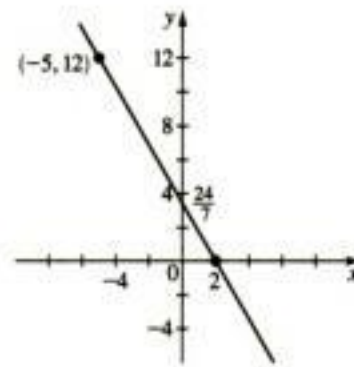

e) $(x - 2)^2 + y^2 = 193$

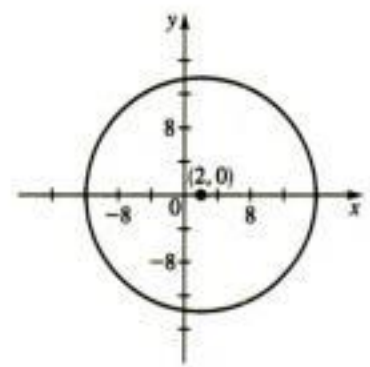

101.

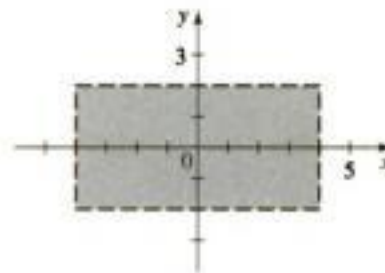

103. B 105. $(x + 5)^2 + (y + 1)^2 = 26$

107. Circunferencia, centro $(-1, 3)$ radio 1

109. No tiene gráfica

111. No hay simetría

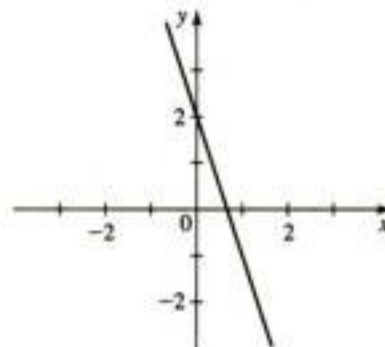

113. No hay simetría

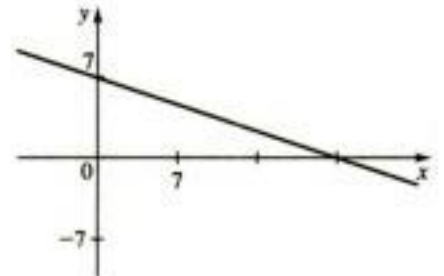

115. Simetría con respecto al eje y

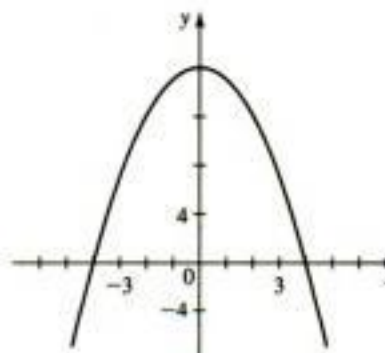

117. No hay simetría

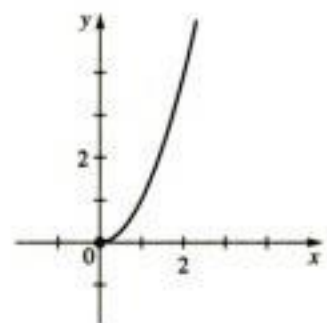

119.

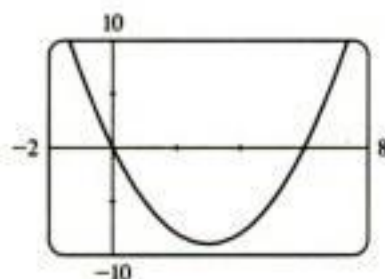

121.

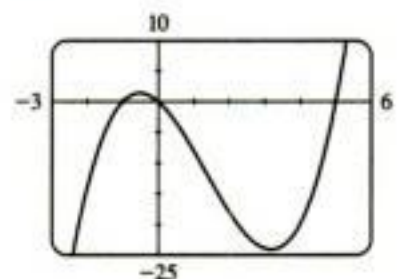

13.



15.

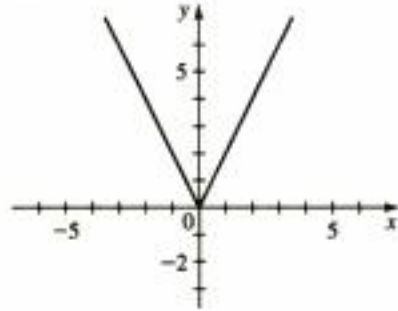

17.

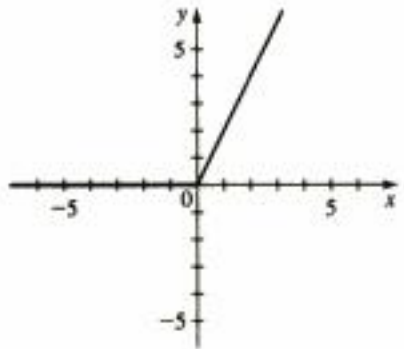

19.

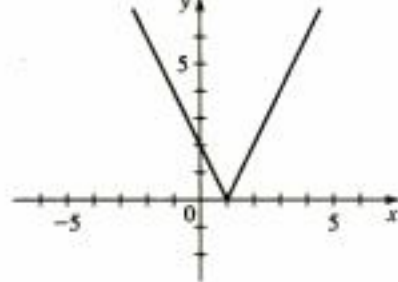

21.

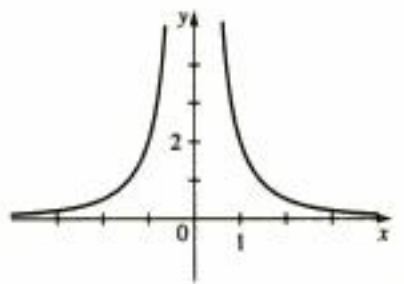

23. a) 1, -1, 3, 4 b) Dominio $[-3, 4]$, rango $[-1, 4]$

25. a) $f(0)$ b) $g(-3)$ c) -2, 2

27. a)

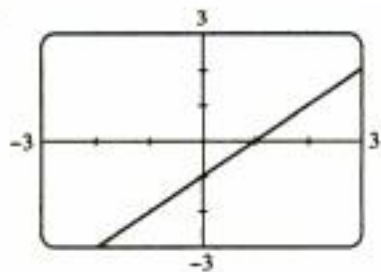

b) Dominio $(-\infty, \infty)$, rango $(-\infty, \infty)$

29. a)

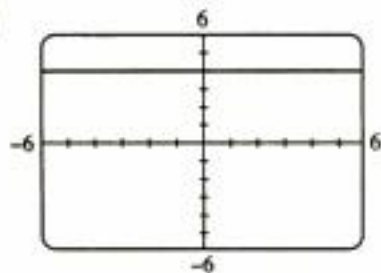

b) Dominio $(-\infty, \infty)$, rango $\{4\}$

31. a)

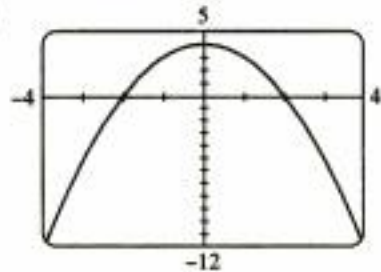

b) Dominio $(-\infty, \infty)$, rango $(-\infty, 4]$

33. a)

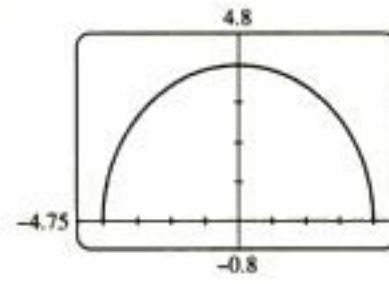

b) Dominio $[-4, 4]$, rango $[0, 4]$

35. a)

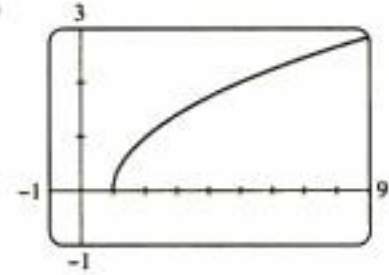

b) Dominio $[1, \infty)$, rango $[0, \infty)$

37.

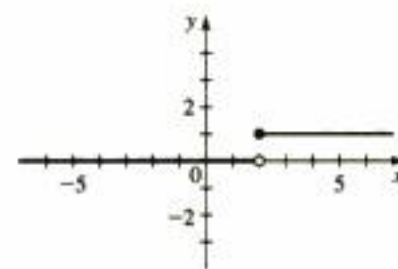

39.

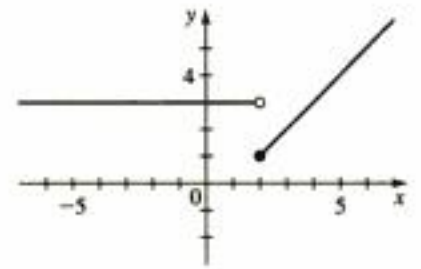

41.

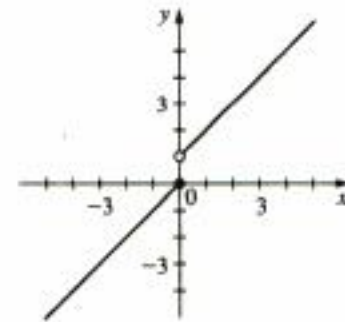

43.

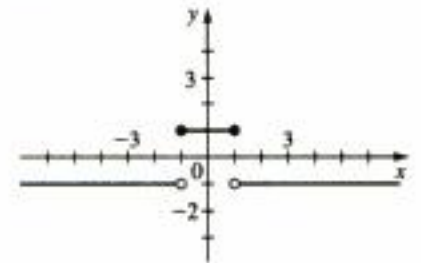

45.

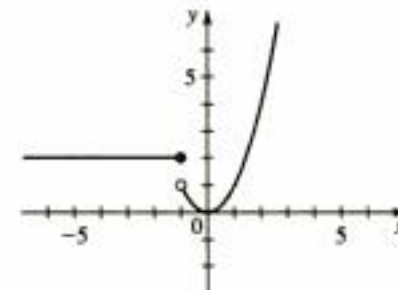

47.

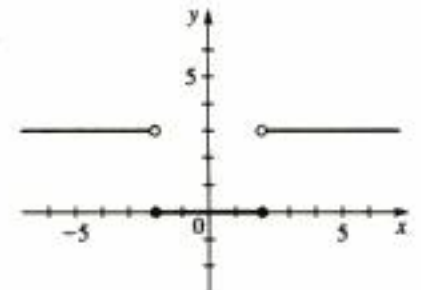

49.

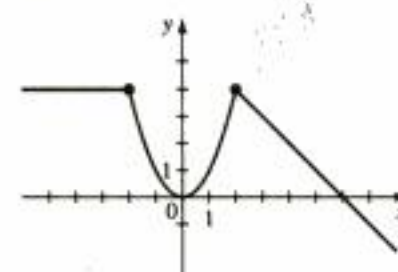

51.

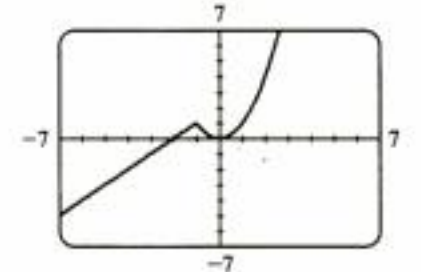

53. $f(x) = \begin{cases} -2 & \text{si } x < -2 \\ x & \text{si } -2 \leq x \leq 2 \\ 2 & \text{si } x > 2 \end{cases}$

55. a) Sí b) No c) Sí d) No

57. Función, dominio $[-3, 2]$, rango $[-2, 2]$ 59. No es una función 61. Sí 63. No 65. No 67. Sí 69. Sí 71. Sí 73. a) b)

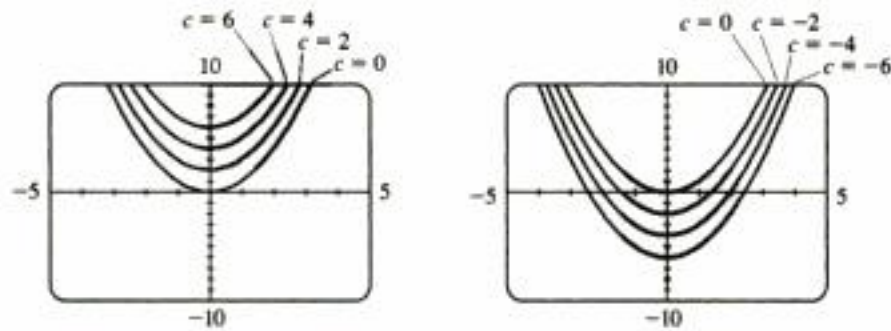

c) Si $c > 0$, entonces la gráfica de $f(x) = x^2 + c$ es la misma que la gráfica de $y = x^2$ desplazada hacia arriba c unidades. Si $c < 0$, entonces la gráfica de $f(x) = x^2 + c$ es la misma que la de $y = x^2$ desplazada hacia abajo c unidades.

75. a) b)

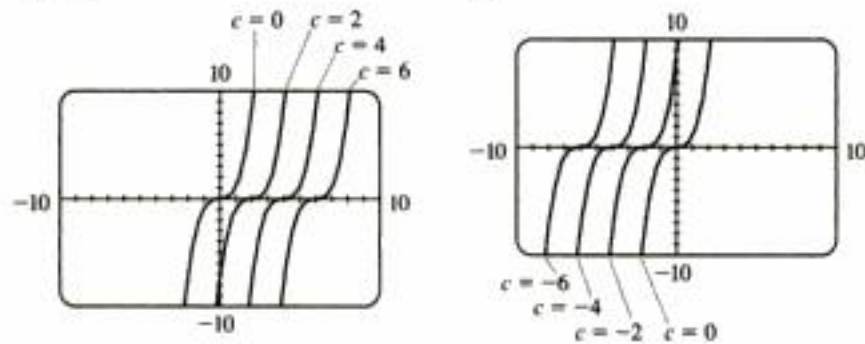

c) Si $c > 0$, entonces la gráfica de $f(x) = (x - c)^3$ es la misma que la gráfica de $y = x^3$ desplazada hacia la derecha c unidades. Si $c < 0$, entonces la gráfica de $f(x) = (x - c)^3$ es la misma que la de $y = x^3$ desplazada hacia la izquierda c unidades.

77. a) b)

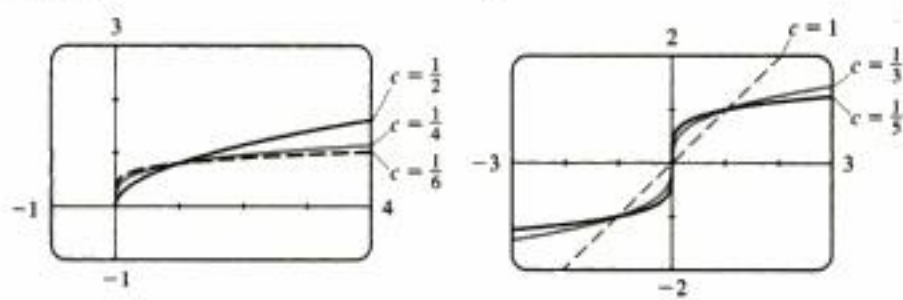

c) Las gráficas de raíces pares son similares a \sqrt{x} ; las gráficas de raíces impares son similares a $\sqrt[3]{x}$. A medida que c se incrementa, la gráfica de $y = \sqrt[n]{x}$ se vuelve más pronunciada cerca de 0 y más plana cuando $x > 1$.

79. $f(x) = -\frac{7}{6}x - \frac{4}{3}, -2 \leq x \leq 4$

81. $f(x) = \sqrt{9 - x^2}, -3 \leq x \leq 3$

83. El peso de esta persona se incrementa a medida que crece, luego sigue en aumento; la persona sigue entonces una dieta rigurosa (quizá) a la edad de 30 años, luego sube otra vez de peso; con el paso del tiempo, el peso se estabiliza. 85. A ganó la carrera. Todos los corredores terminaron. El corredor B cayó, pero se levantó para llegar en segundo lugar.

87. a) 5 s b) 30 s c) 17 s

89. $C(x) = \begin{cases} 2 & 0 < x \leq 1 \\ 2.2 & 1 < x \leq 1.1 \\ 2.4 & 1.1 < x \leq 1.2 \\ \vdots & \\ 4.0 & 1.9 < x < 2.0 \end{cases}$

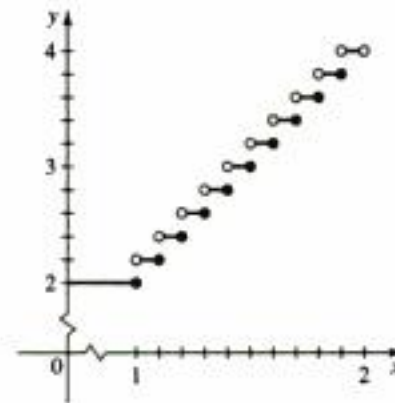

Sección 2.3 ■ página 179

1. a) $[-1, 1], [2, 4]$ b) $[1, 2]$ 3. a) $[-2, -1], [1, 2]$

b) $[-3, -2], [-1, 1], [2, 3]$

5. a)

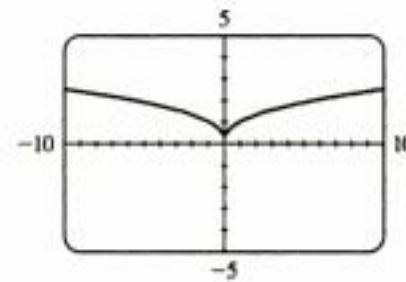

b) Creciente en $[0, \infty)$; decreciente en $(-\infty, 0]$

9. a)

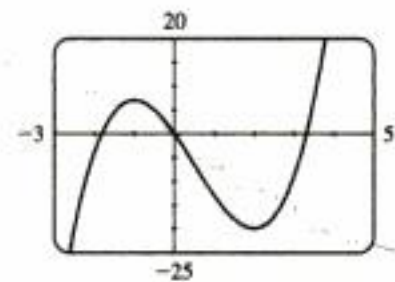

b) Creciente en $(-\infty, -1]$, $[2, \infty)$; decreciente en $[-1, 2]$

7. a)

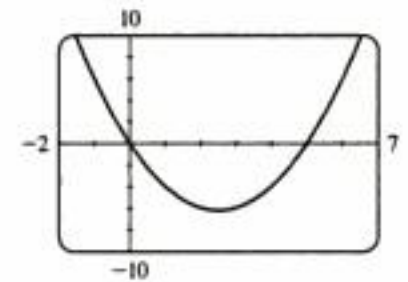

b) Creciente en $[2.5, \infty)$; decreciente en $(-\infty, 2.5]$

11. a)

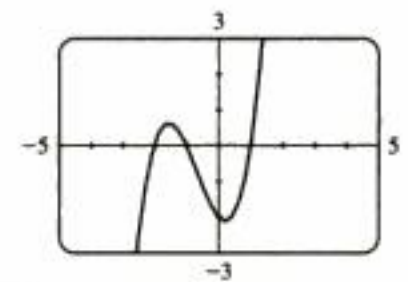

b) Creciente en $(-\infty, -1.55]$, $[0.22, \infty)$; decreciente en $[-1.55, 0.22]$

13. $\frac{2}{3}$ 15. $-\frac{4}{5}$ 17. 3 19. 5 21. 60

23. $12 + 3h$ 25. $-\frac{1}{a}$ 27. $\frac{-2}{a(a+h)}$ 29. a) $\frac{1}{2}$

31. a) Creciente en $[0, 150], [300, 365]$; decreciente en $[150, 300]$ b) -0.25 pies/día 33. a) 245 personas/año

b) -328.5 personas/año c) 1997-2001 d) 2001-2006

35. a) 7.2 unidades/año b) 8 unidades/año

c) -55 unidades/año d) 2000-2001, 2001-2002

Sección 2.4 ■ página 190

1. a) Muévase hacia abajo 5 unidades b) Desplácese a la derecha 5 unidades
 3. a) Desplácese a la izquierda $\frac{1}{2}$ unidad b) Suba $\frac{1}{2}$ de unidad
 5. a) Refleje en el eje x y estira verticalmente en un factor de 2
 b) Refleje en el eje x y contraiga verticalmente en un factor de $\frac{1}{2}$
 7. a) Diríjase a la derecha 4 unidades y suba $\frac{3}{4}$ de unidad
 b) Vaya a la izquierda 4 unidades y baje $\frac{3}{4}$ de unidad
 9. a) Contraiga en el sentido horizontal por un factor de $\frac{1}{4}$
 b) Estire en la dirección horizontal por un factor de 4
 11. $g(x) = (x - 2)^2$
 13. $g(x) = |x + 1| + 2$ 15. $g(x) = -\sqrt{x + 2}$
 17. a) 3 b) 1 c) 2 d) 4

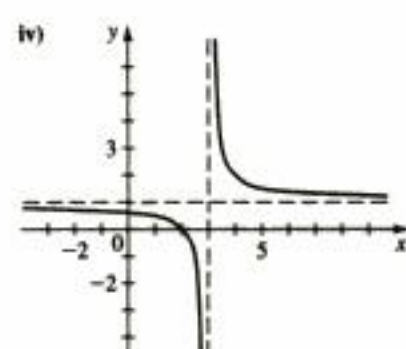
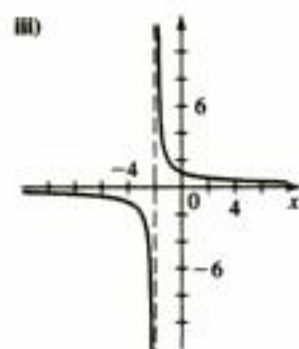
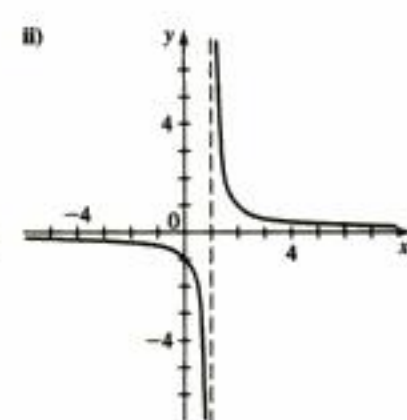
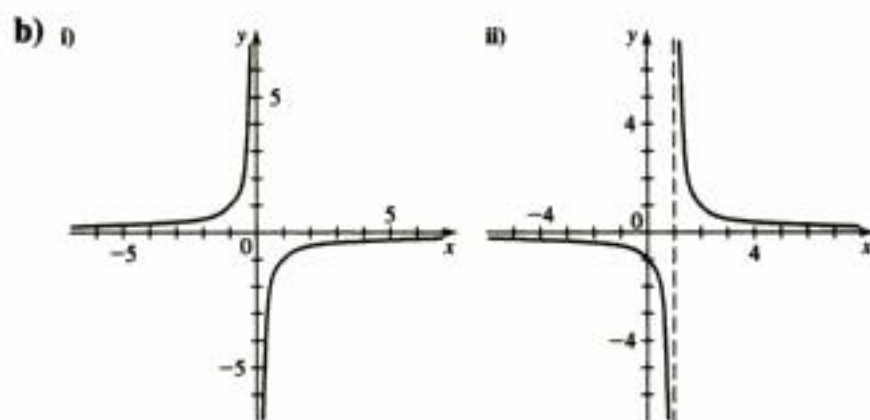
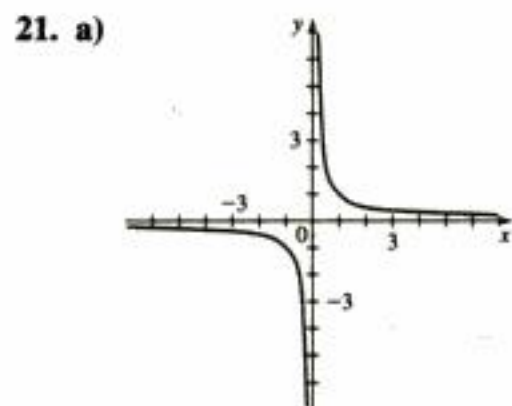
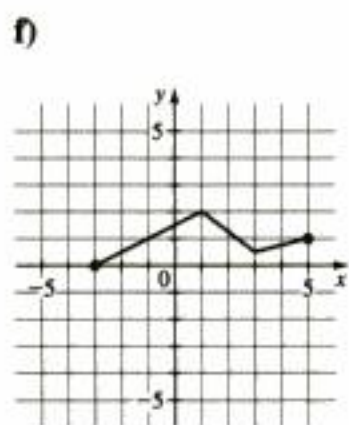
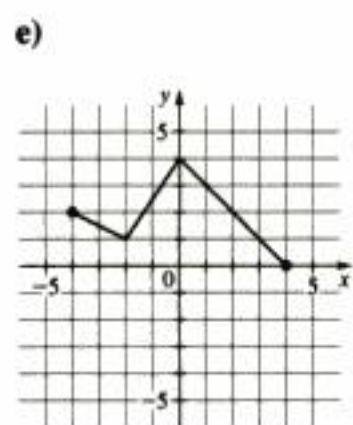
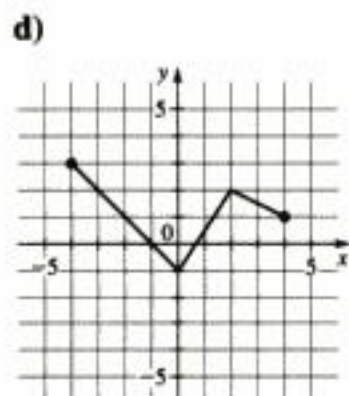
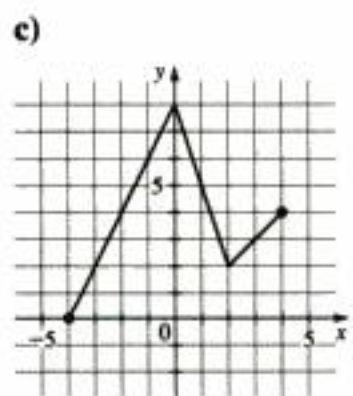
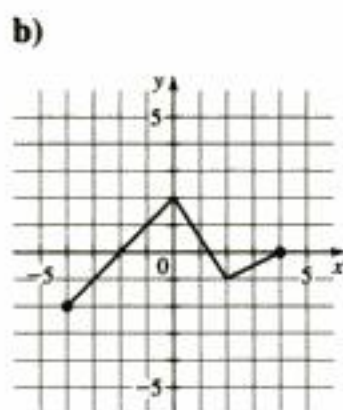
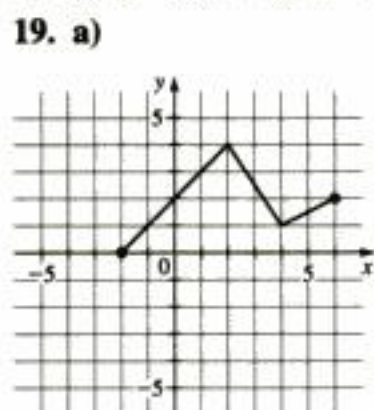

23. a) Desplácese a la izquierda 2 unidades
 b) Suba 2 unidades
 25. a) Estire verticalmente por un factor de 2
 b) Vaya a la derecha 2 unidades, luego contraiga verticalmente por un factor de $\frac{1}{2}$
 27. $g(x) = (x - 2)^2 + 3$ 29. $g(x) = -5\sqrt{x + 3}$
 31. $g(x) = 0.1|x - \frac{1}{2}| - 2$

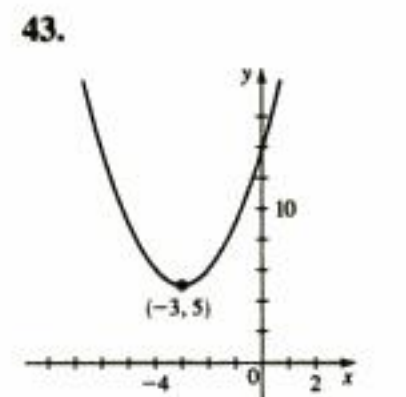
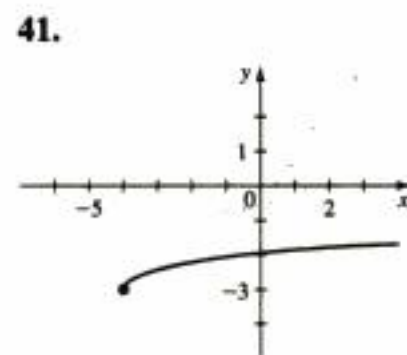
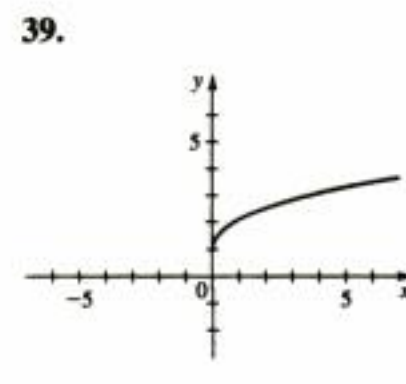
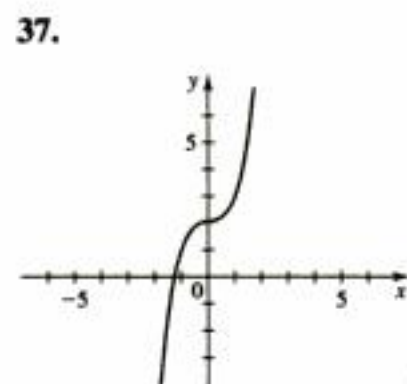
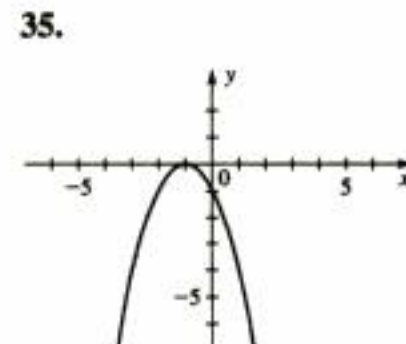
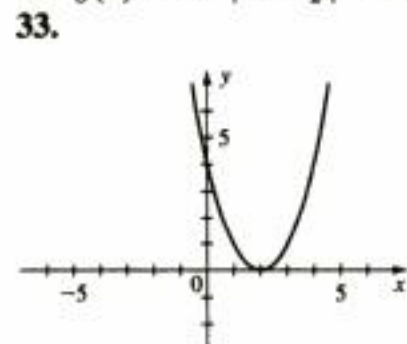

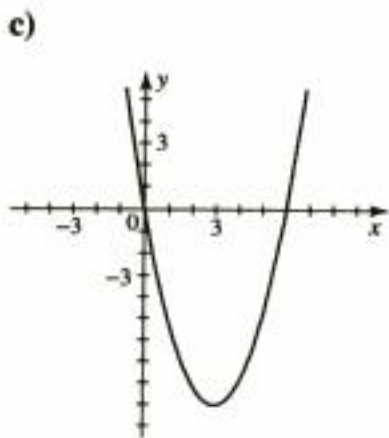

9. a) $f(x) = (x + 2)^2 - 1$
 b) Vértice $(-2, -1)$
 intersección con x en $-1, -3$
 intersección con y en 3

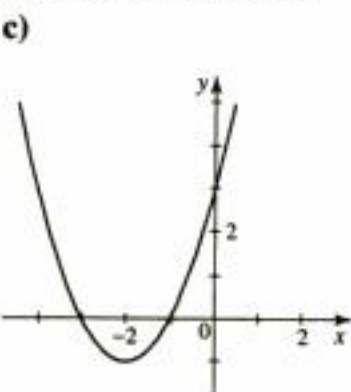

13. a) $f(x) = 2(x + 1)^2 + 1$ b) Vértice $(-1, 1)$;
 no corta a x ; intersección con y en 3

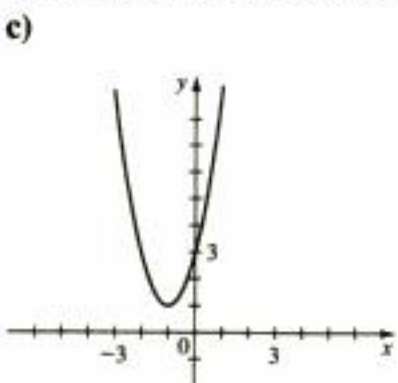

15. a) $f(x) = 2(x - 5)^2 + 7$ b) Vértice $(5, 7)$;
 no corta a x ; intersección con y en 57

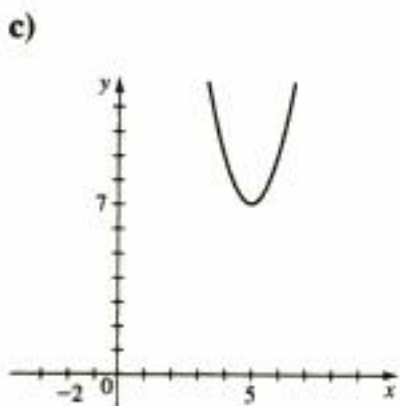

17. a) $f(x) = -4(x + 2)^2 + 19$ b) Vértice $(-2, 19)$;
 intersección con x en $-2 \pm \frac{1}{2}\sqrt{19}$; intersección con y en 3

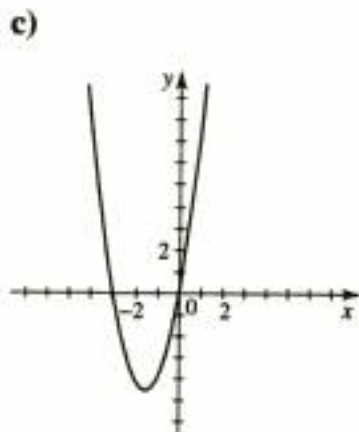

11. a) $f(x) = -(x - 3)^2 + 13$
 b) Vértice $(3, 13)$;
 intersección con x en $3 \pm \sqrt{13}$;
 intersección con y en 4

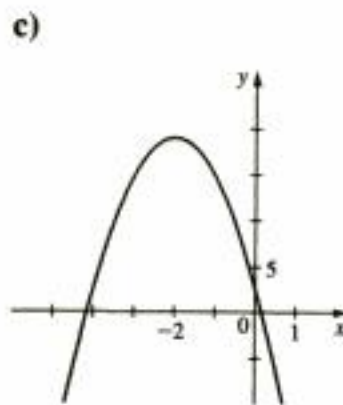
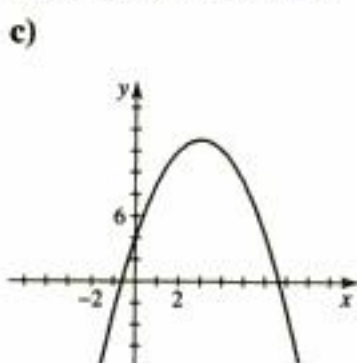

19. a) $f(x) = -(x - 1)^2 + 1$ b) Vértice $(1, 1)$;
 intersección con x en $0, 2$;
 intersección con y en 5

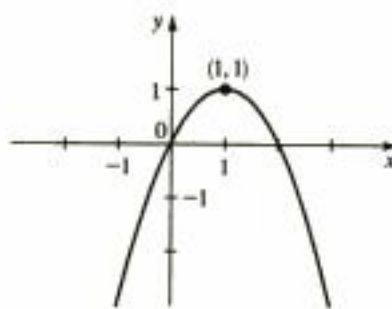

c) Máximo $f(1) = 1$

23. a) $f(x) = -(x + \frac{3}{2})^2 + \frac{21}{4}$

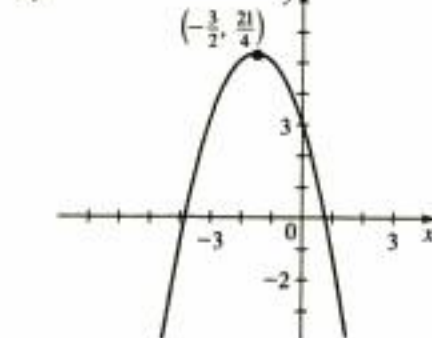

c) Máximo $f(-\frac{3}{2}) = \frac{21}{4}$

25. a) $g(x) = 3(x - 2)^2 + 1$

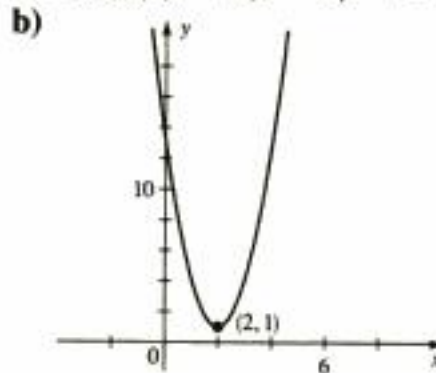

c) Mínimo $g(2) = 1$

27. a) $h(x) = -(x + \frac{1}{2})^2 + \frac{5}{4}$

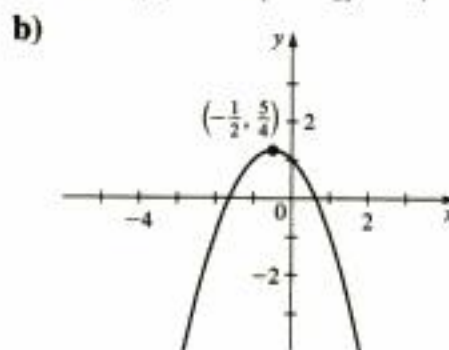

21. a) $f(x) = (x + 1)^2 - 2$

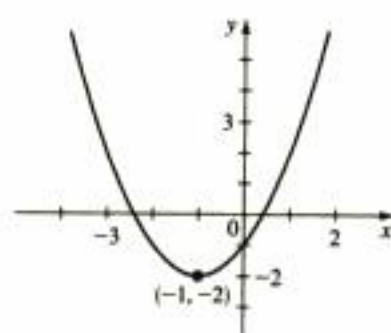

c) Mínimo $f(-1) = -2$

$$(f \circ f)(x) = \frac{x}{2x + 1}, x \neq -1, x \neq -\frac{1}{2};$$

$$(g \circ g)(x) = 4x - 3, (-\infty, \infty)$$

$$39. (f \circ g)(x) = \sqrt[3]{2x}, [0, \infty); (g \circ f)(x) = \sqrt[3]{2x}, [0, \infty);$$

$$(f \circ f)(x) = \sqrt[9]{x}, (-\infty, \infty); (g \circ g)(x) = \sqrt[12]{x}, [0, \infty)$$

$$41. (f \circ g \circ h)(x) = \sqrt{x - 1} - 1$$

$$43. (f \circ g \circ h)(x) = (\sqrt{x} - 5)^4 + 1$$

$$45. g(x) = x - 9, f(x) = x^5$$

$$47. g(x) = x^2, f(x) = x/(x + 4)$$

$$49. g(x) = 1 - x^3, f(x) = |x|$$

$$51. h(x) = x^2, g(x) = x + 1, f(x) = 1/x$$

$$53. h(x) = \sqrt[3]{x}, g(x) = 4 + x, f(x) = x^9$$

$$55. R(x) = 0.15x - 0.000002x^2 \quad 57. \text{ a) } g(t) = 60t$$

$$\text{b) } f(r) = \pi r^2 \quad \text{c) } (f \circ g)(t) = 3600\pi t^2$$

$$59. A(t) = 16\pi t^2 \quad 61. \text{ a) } f(x) = 0.9x \quad \text{b) } g(x) = x - 100$$

$$\text{c) } f \circ g(x) = 0.9x - 90, g \circ f(x) = 0.9x - 100, f \circ g:$$

primero rebaja, luego descuento, $g \circ f$: primero descuento, luego rebaja, $g \circ f$ es la mejor opción

Sección 2.8 ■ página 230

1. No 3. Sí 5. No 7. Sí 9. Sí 11. No 13. No

15. No 17. a) 2 b) 3 19. 1

$$31. f^{-1}(x) = \frac{1}{2}(x - 1) \quad 33. f^{-1}(x) = \frac{1}{4}(x - 7)$$

$$35. f^{-1}(x) = 2x \quad 37. f^{-1}(x) = (1/x) - 2$$

$$39. f^{-1}(x) = (5x - 1)/(2x + 3)$$

$$41. f^{-1}(x) = \frac{1}{5}(x^2 - 2), x \geq 0$$

$$43. f^{-1}(x) = \sqrt{4 - x}, x \leq 4 \quad 45. f^{-1}(x) = (x - 4)^3$$

$$47. f^{-1}(x) = x^2 - 2x, x \geq 1 \quad 49. f^{-1}(x) = \sqrt[4]{x}$$

51. a)

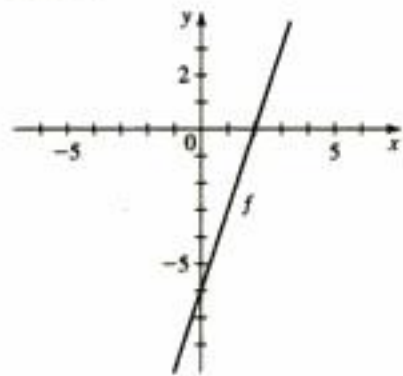

$$\text{c) } f^{-1}(x) = \frac{1}{3}(x + 6)$$

53. a)

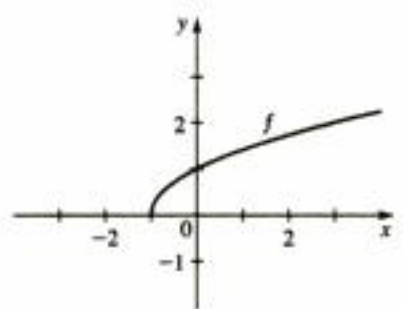

$$\text{c) } f^{-1}(x) = x^2 - 1, x \geq 0$$

b)

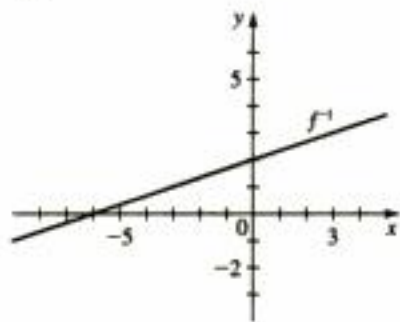

b)

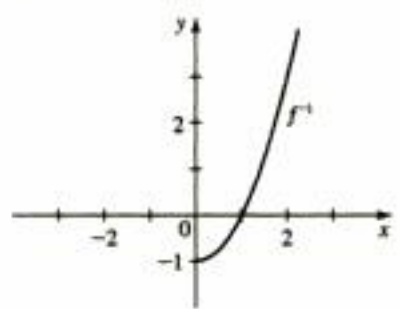

55. No es uno a uno

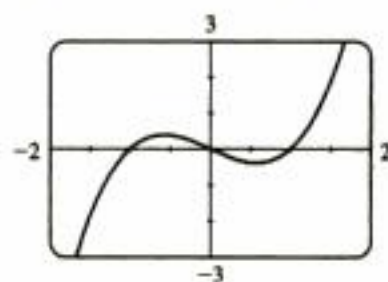

59. No es uno a uno

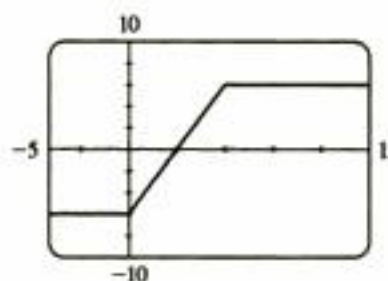

61. a) $f^{-1}(x) = x - 2$

b)

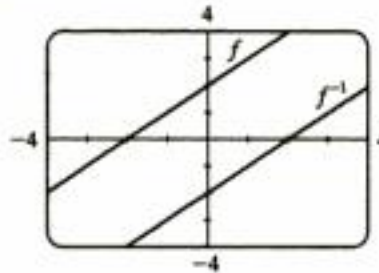

63. a) $g^{-1}(x) = x^2 - 3, x \geq 0$

b)

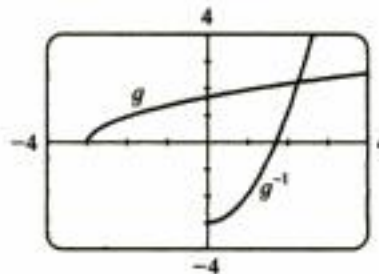

65. $x \geq 0, f^{-1}(x) = \sqrt{4 - x}$

67. $x \geq -2, h^{-1}(x) = \sqrt{x} - 2$

69.

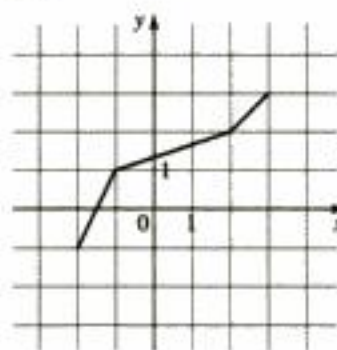

71. a) $f(x) = 500 + 80x$ b) $f^{-1}(x) = \frac{1}{80}(x - 500)$, la cantidad de horas laboradas en función de la tarifa
c) 9; si él carga 1220 dólares, trabaja 9 h

73. a) $v^{-1}(t) = \sqrt{0.25 - \frac{t}{18500}}$ b) 0.498; a una distancia de 0.498 desde el eje central, la velocidad es 30

75. a) $F^{-1}(x) = \frac{5}{9}(x - 32)$; la temperatura Celsius cuando la temperatura Fahrenheit es x

b) $F^{-1}(86) = 30$; cuando la temperatura es 86°F , es de 30°C

c) $(fg)(x) = -3x^3 + 13x^2 - 18x + 8$

d) $(f/g)(x) = (x^2 - 3x + 2)/(4 - 3x)$

e) $(f \circ g)(x) = 9x^2 - 15x + 6$

f) $(g \circ f)(x) = -3x^2 + 9x - 2$

65. $(f \circ g)(x) = -3x^2 + 6x - 1, (-\infty, \infty);$

$(g \circ f)(x) = -9x^2 + 12x - 3, (-\infty, \infty); (f \circ f)(x) = 9x - 4,$

$(-\infty, \infty); (g \circ g)(x) = -x^4 + 4x^3 - 6x^2 + 4x, (-\infty, \infty)$

67. $(f \circ g \circ h)(x) = 1 + \sqrt{x}$

69. Sí 71. No 73. No

75. $f^{-1}(x) = \frac{x+2}{3}$

77. $f^{-1}(x) = \sqrt[3]{x} - 1$

79. a), b)

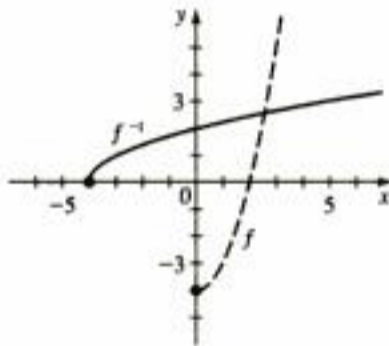

c) $f^{-1}(x) = \sqrt{x+4}$

Capítulo 2 Evaluación ■ página 237

1. a) y b) son gráficas de funciones, a) es uno a uno 3. 5

5. a) Desplácese a la derecha 3 unidades, luego hacia arriba 2 unidades b) Refleje en el eje y

7. a) -3, 3 b)

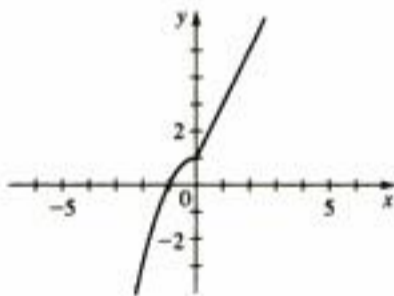

9. a) $(f \circ g)(x) = (x - 3)^2 + 1$ b) $(g \circ f)(x) = x^2 - 2$

c) 2 d) 2 e) $(g \circ g \circ g)(x) = x - 9$

11. a) Dominio $[0, 6]$, rango $[1, 7]$

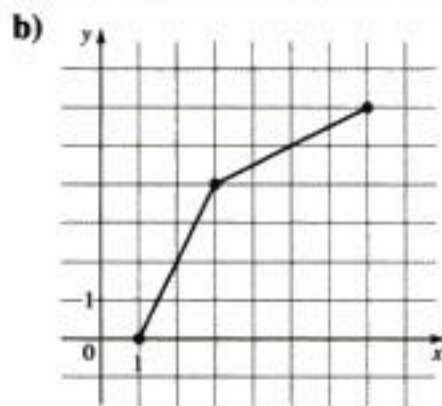

c) $\frac{5}{4}$

Enfoque en el modelado ■ página 243

1. a)

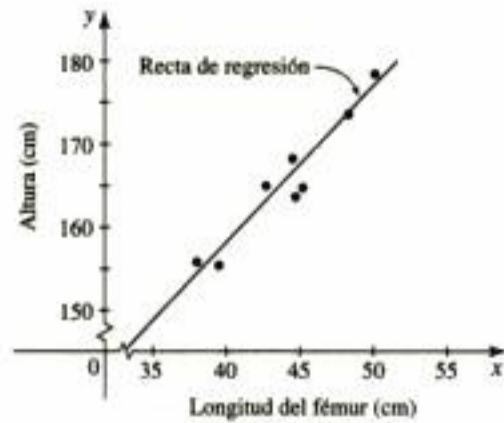

b) $y = 1.8807x + 82.65$ c) 191.7 cm

3. a)

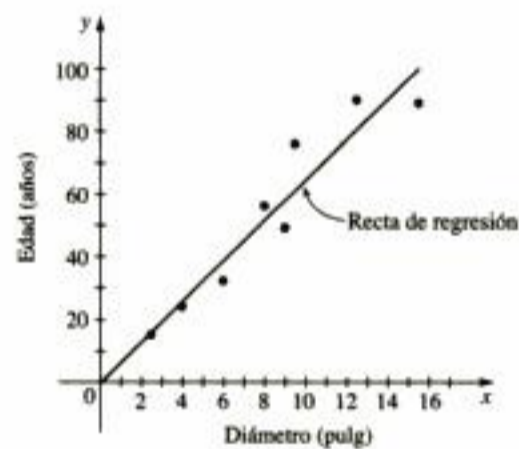

b) $y = 6.451x - 0.1523$ c) 116 años

5. a)

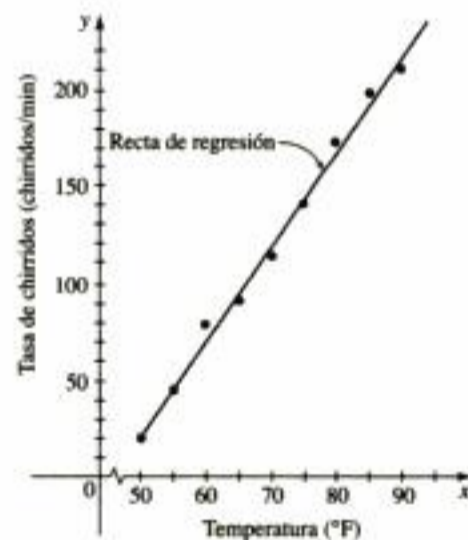

b) $y = 4.857x - 220.97$ c) 265 chirridos/min

7. a)

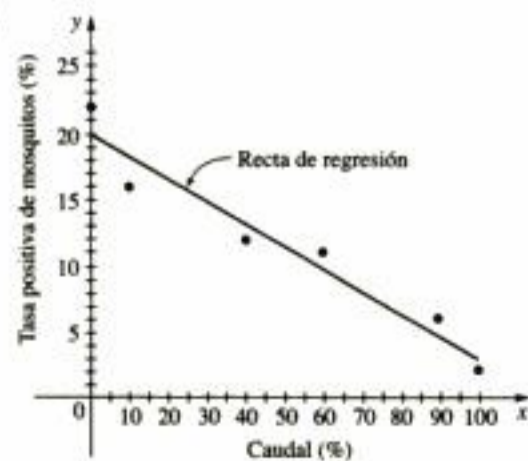

b) $y = -0.168x + 19.89$ c) 8.13%

57. a) -1, 2

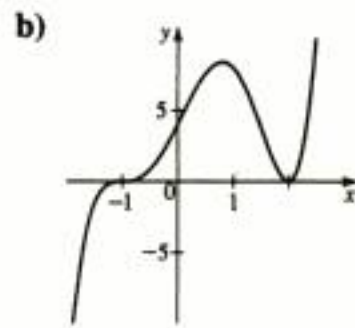

59. 1 positivo, 2 o 0 negativos; 3 o 1 reales
 61. 1 positivo, 1 negativo; 2 reales
 63. 2 o 0 positivos, 0 negativo; 3 o 1 real (puesto que 0 es un cero, pero ni es positivo ni negativo) 69. 3, -2
 71. 3, -1 73. $-2, \frac{1}{2}, \pm 1$ 75. $\pm \frac{1}{2}, \pm \sqrt{5}$
 77. -2, 1, 3, 4 83. -2, 2, 3 85. $-\frac{3}{2}, -1, 1, 4$
 87. -1.28, 1.53 89. -1.50 93. 11.3 pies
 95. a) Empieza a nevar otra vez. b) No c) Justo antes de medianoche del sábado 97. 2.76 m 99. 88 pulg (o 3.21 pulg).

Sección 3.4 ■ página 289

1. Parte real 5, parte imaginaria -7 3. Parte real $-\frac{2}{3}$, parte imaginaria $-\frac{5}{3}$ 5. Parte real 3, parte imaginaria 0
 7. Parte real 0, parte imaginaria $-\frac{2}{3}$ 9. Parte real $\sqrt{3}$, parte imaginaria 2 11. $5 - i$ 13. $3 + 5i$ 15. $6 - i$
 17. $2 - 2i$ 19. $-19 + 4i$ 21. $-\frac{1}{4} + \frac{1}{2}i$
 23. $-4 + 8i$ 25. $30 + 10i$ 27. $-33 - 56i$ 29. $27 - 8i$
 31. $-i$ 33. $\frac{8}{3} + \frac{1}{3}i$ 35. $-5 + 12i$ 37. $-4 + 2i$
 39. $2 - \frac{4}{3}i$ 41. $-i$ 43. $-i$ 45. 1 47. $5i$ 49. -6
 51. $(3 + \sqrt{5}) + (3 - \sqrt{5})i$ 53. 2 55. $-i\sqrt{2}$ 57. $\pm 3i$
 59. $2 \pm i$ 61. $-\frac{1}{2} \pm \frac{\sqrt{3}}{2}i$ 63. $\frac{1}{2} \pm \frac{1}{2}i$ 65. $-\frac{3}{2} \pm \frac{\sqrt{3}}{2}i$
 67. $\frac{-6 \pm \sqrt{6}i}{6}$ 69. $1 \pm 3i$

Sección 3.5 ■ página 298

1. a) 0, $\pm 2i$ b) $x^2(x - 2i)(x + 2i)$
 3. a) 0, $1 \pm i$ b) $x(x - 1 - i)(x - 1 + i)$
 5. a) $\pm i$ b) $(x - i)^2(x + i)^2$
 7. a) $\pm 2, \pm 2i$ b) $(x - 2)(x + 2)(x - 2i)(x + 2i)$
 9. a) $-2, 1 \pm i\sqrt{3}$
 b) $(x + 2)(x - 1 - i\sqrt{3})(x - 1 + i\sqrt{3})$
 11. a) $\pm 1, \frac{1}{2} \pm \frac{1}{2}i\sqrt{3}, -\frac{1}{2} \pm \frac{1}{2}i\sqrt{3}$
 b) $(x - 1)(x + 1)(x - \frac{1}{2} - \frac{1}{2}i\sqrt{3})(x - \frac{1}{2} + \frac{1}{2}i\sqrt{3}) \times (x + \frac{1}{2} - \frac{1}{2}i\sqrt{3})(x + \frac{1}{2} + \frac{1}{2}i\sqrt{3})$

En las respuestas 13 a 30, la forma factorizada se anota primero, luego se proporciona un listado de los ceros y la multiplicidad de cada uno entre paréntesis

13. $(x - 5i)(x + 5i); \pm 5i(1)$
 15. $[x - (-1 + i)][x - (-1 - i)]; -1 + i(1), -1 - i(1)$

17. $x(x - 2i)(x + 2i); 0(1), 2i(1), -2i(1)$
 19. $(x - 1)(x + 1)(x - i)(x + i); 1(1), -1(1), i(1), -i(1)$
 21. $16(x - \frac{3}{2})(x + \frac{3}{2})(x - \frac{3}{2}i)(x + \frac{3}{2}i); \frac{3}{2}(1), -\frac{3}{2}(1), \frac{3}{2}i(1), -\frac{3}{2}i(1)$
 23. $(x + 1)(x - 3i)(x + 3i); -1(1), 3i(1), -3i(1)$
 25. $(x - i)^2(x + i)^2; i(2), -i(2)$
 27. $(x - 1)(x + 1)(x - 2i)(x + 2i); 1(1), -1(1), 2i(1), -2i(1)$
 29. $x(x - i\sqrt{3})^2(x + i\sqrt{3})^2; 0(1), i\sqrt{3}(2), -i\sqrt{3}(2)$
 31. $P(x) = x^2 - 2x + 2$ 33. $Q(x) = x^3 - 3x^2 + 4x - 12$
 35. $P(x) = x^3 - 2x^2 + x - 2$
 37. $R(x) = x^4 - 4x^3 + 10x^2 - 12x + 5$
 39. $T(x) = 6x^4 - 12x^3 + 18x^2 - 12x + 12$
 41. $-2, \pm 2i$ 43. $1, \frac{1 \pm i\sqrt{3}}{2}$ 45. $2, \frac{1 \pm i\sqrt{3}}{2}$
 47. $-\frac{3}{2}, -1 \pm i\sqrt{2}$ 49. $-2, 1, \pm 3i$
 51. $1, \pm 2i, \pm i\sqrt{3}$ 53. 3 (multiplicidad 2), $\pm 2i$
 55. $-\frac{1}{2}$ (multiplicidad 2), $\pm i$ 57. 1 (multiplicidad 3), $\pm 3i$
 59. a) $(x - 5)(x^2 + 4)$ b) $(x - 5)(x - 2i)(x + 2i)$
 61. a) $(x - 1)(x + 1)(x^2 + 9)$
 b) $(x - 1)(x + 1)(x - 3i)(x + 3i)$
 63. a) $(x - 2)(x + 2)(x^2 - 2x + 4)(x^2 + 2x + 4)$
 b) $(x - 2)(x + 2)[x - (1 + i\sqrt{3})][x - (1 - i\sqrt{3})] \times [x + (1 + i\sqrt{3})][x + (1 - i\sqrt{3})]$
 65. a) 4 real b) 2 real, 2 imaginario c) 4 imaginario

Sección 3.6 ■ página 312

1. a) $-3, -19, -199, -1999; 5, 21, 201, 2001; 1.2500, 1.0417, 1.0204, 1.0020; 0.8333, 0.9615, 0.9804, 0.9980$
 b) $r(x) \rightarrow -\infty$ cuando $x \rightarrow 2^-; r(x) \rightarrow \infty$ cuando $x \rightarrow 2^+$
 c) Asíntota horizontal $y = 1$
 3. a) $-22, -430, -40\,300, -4\,003\,000; -10, -370, -39\,700, -3\,997\,000; 0.3125, 0.0608, 0.0302, 0.0030; -0.2778, -0.0592, -0.0298, -0.0030$
 b) $r(x) \rightarrow -\infty$ cuando $x \rightarrow 2^-; r(x) \rightarrow -\infty$ cuando $x \rightarrow 2^+$
 c) Asíntota horizontal $y = 0$
 5. Corta a x en 1, corta a y en $-\frac{1}{4}$
 7. intersección con x en $-1, 2$; intersección con y en $\frac{1}{3}$
 9. intersección con x en $-3, 3$; no hay corte en y
 11. intersección con x en 3, intersección con y en 3, vertical $x = 2$; horizontal $y = 2$
 13. corta a x en $-1, 1$; intersección con y en $\frac{1}{4}$; vertical $x = -2, x = 2$; horizontal $y = 1$
 15. Vertical $x = -2$; horizontal $y = 0$
 17. Vertical $x = 3, x = -2$; horizontal $y = 1$
 19. Horizontal $y = 0$
 21. Vertical $x = -6, x = 1$; horizontal $y = 0$
 23. Vertical $x = 1$

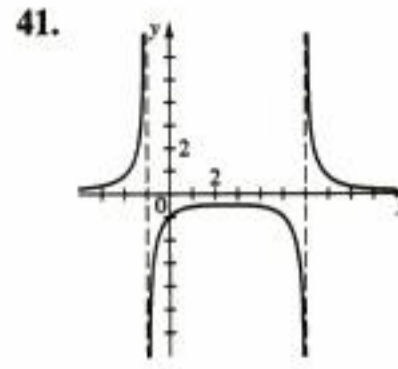
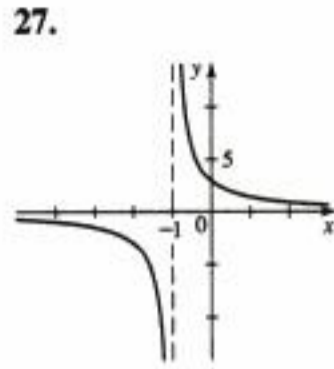
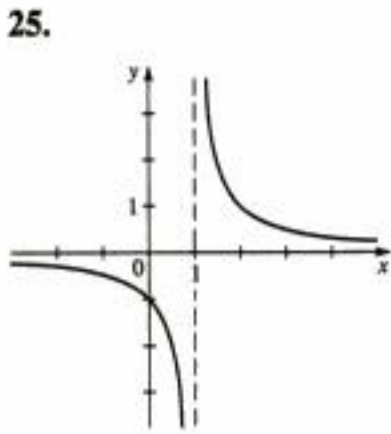

intersección con y en -1
vertical $x = -1, x = 6$
horizontal $y = 0$

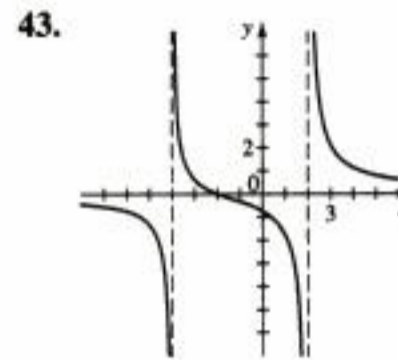
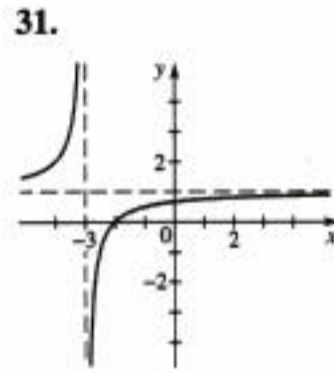
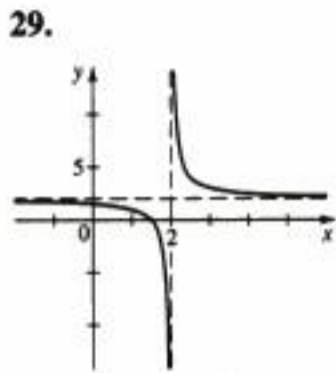

intersección con x en -2
intersección con y en $-\frac{3}{4}$
vertical $x = -4, x = 2$
horizontal $y = 0$

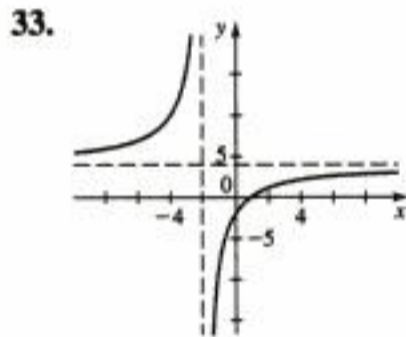

intersección con x en 1
intersección con y en -2
vertical $x = -2$
horizontal $y = 4$

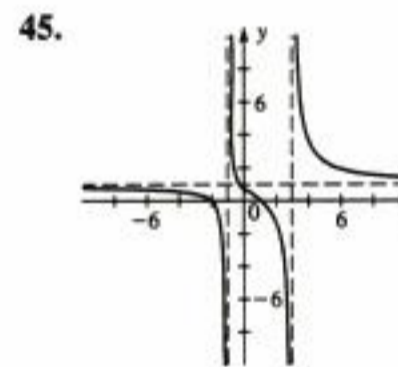

intersección con x en $-2, 1$
intersección con y en $\frac{3}{2}$
vertical $x = -1, x = 3$
horizontal $y = 1$

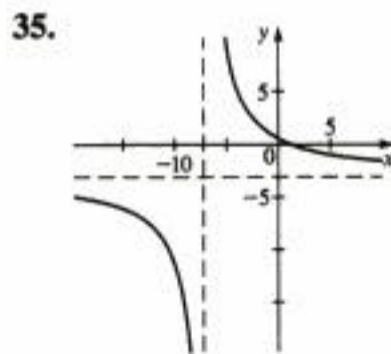

intersección con x en $\frac{4}{3}$
intersección con y en $\frac{4}{3}$
vertical $x = -7$
horizontal $y = -3$

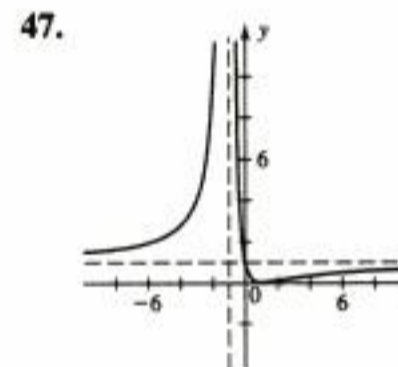

intersección con x en 1
intersección con y en 1
vertical $x = -1$
horizontal $y = 1$

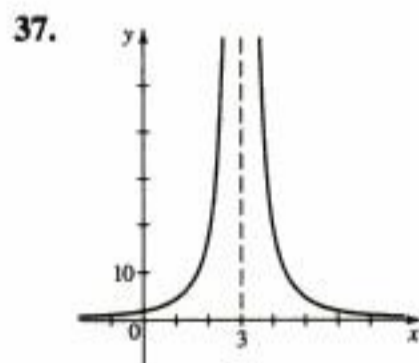

intersección con y en 2
vertical $x = 3$
horizontal $y = 0$

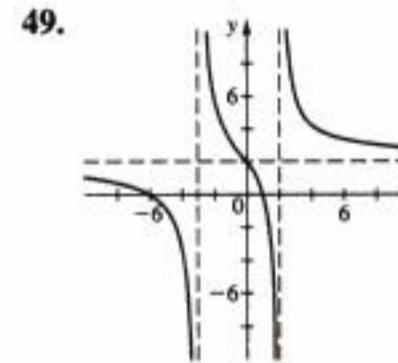

intersección con x en $-6, 1$
intersección con y en 2
vertical $x = -3, x = 2$
horizontal $y = 2$

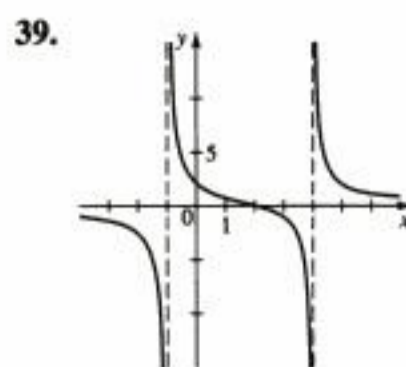

intersección con x en 2
intersección con y en 2
vertical $x = -1, x = 4$
horizontal $y = 0$

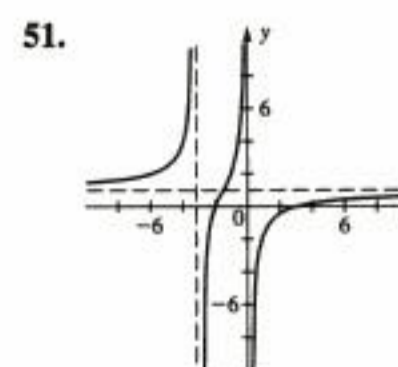

intersección con x en $-2, 3$
vertical $x = -3, x = 0$
horizontal $y = 1$

69.

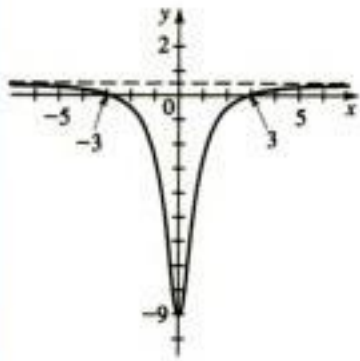

71.

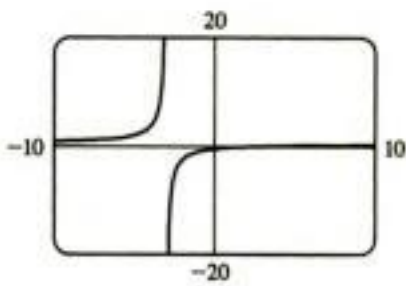

intersección con x en 3
corta a y en -0.5
vertical $x = -3$
horizontal $y = 0.5$
no hay puntos extremos
locales

73.

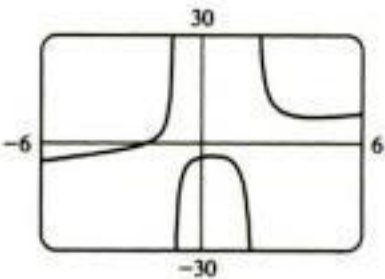

intersección con x en -2
corta a y en -4
vertical $x = -1, x = 2$
asíntota inclinada $y = x + 1$
máximo local
(0.425, -3.599)
mínimo local
(4.216, 7.175)

75. $(-2, -28), (1, 26), (2, 68), (5, 770)$

Capítulo 3 Evaluación ■ página 319

1.

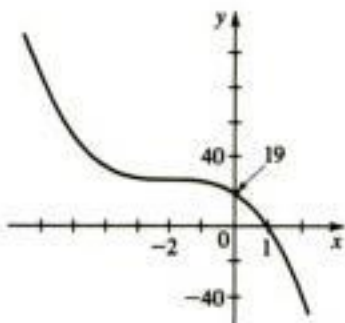

3. a) $\pm 1, \pm 3, \pm \frac{1}{2}, \pm \frac{3}{2}$ b) $2(x - 3)(x - \frac{1}{2})(x + 1)$

c) $-1, \frac{1}{2}, 3$

d)

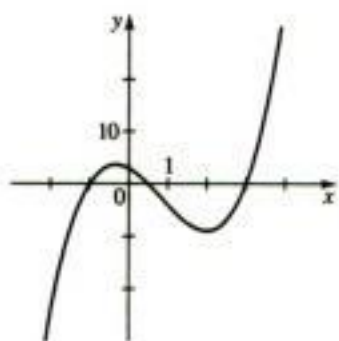

5. $3, -1 \pm i$

7. $x^4 + 2x^3 + 10x^2 + 18x + 9$

9. a) r, u b) s c) s d)

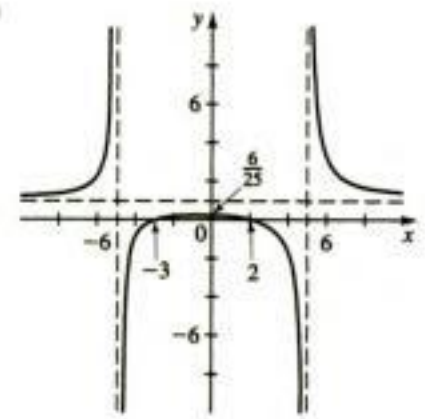

e) $x^2 - 2x - 5$

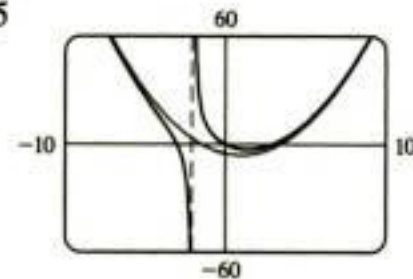

Enfoque en el modelado ■ página 323

1. a) $y = -0.275428x^2 + 19.7485x - 273.5523$

b)

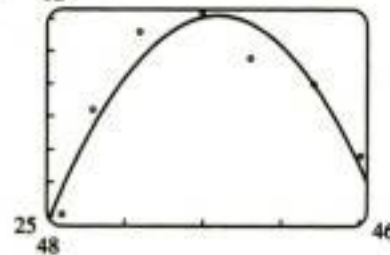

c) 35.85 lb/pulg²

3. a) $y = 0.00203708x^3 - 0.104521x^2 + 1.966206x + 1.45576$

b)

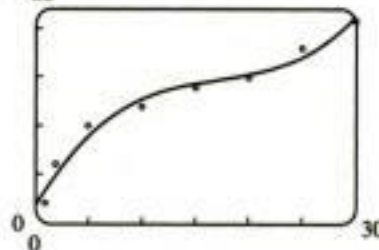

c) 43 verduras d) 2.0 s

5. a) Grado 2

b) $y = -16.0x^2 + 51.8429x + 4.20714$

c)

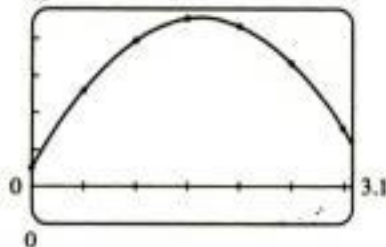

c) 0.3 s y 2.9 s d) 46.2 pies

Capítulo 4

Sección 4.1 ■ página 336

1. 2.000, 7.103, 77.880, 1.587

3. 0.885, 0.606, 0.117, 1.837

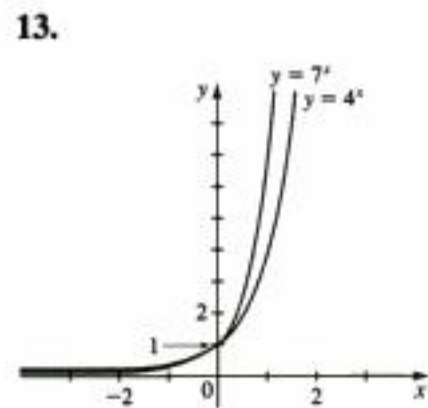
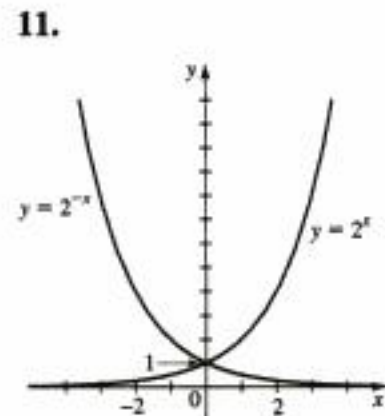
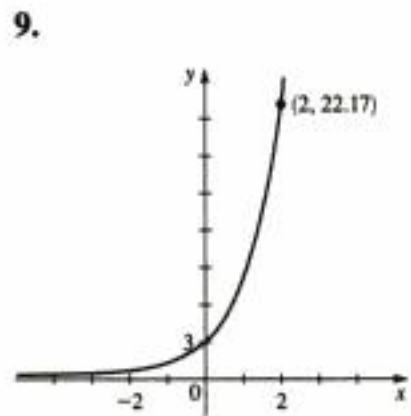
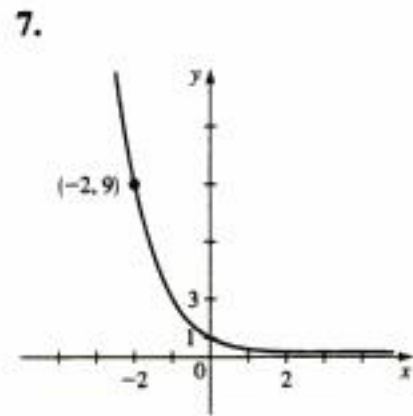
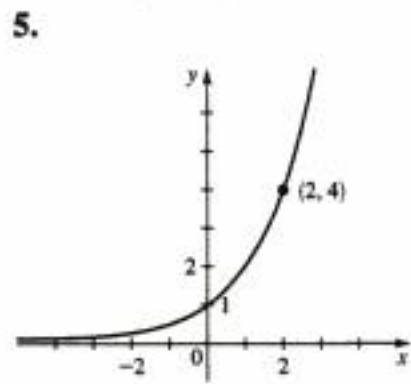

33. $\mathbb{R}, (-\infty, 0), y = 0$

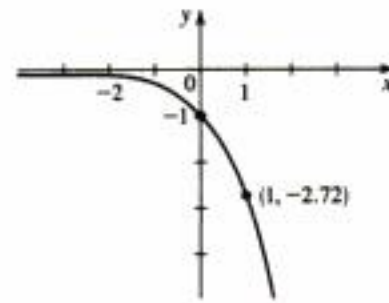

35. $\mathbb{R}, (-1, \infty), y = -1$

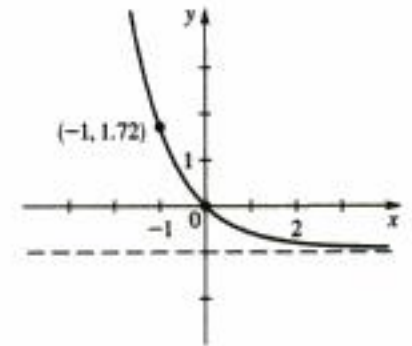

37. $\mathbb{R}, (0, \infty), y = 0$

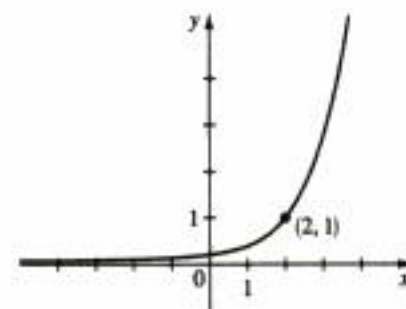

39. $y = 3(2^x)$

41. a)

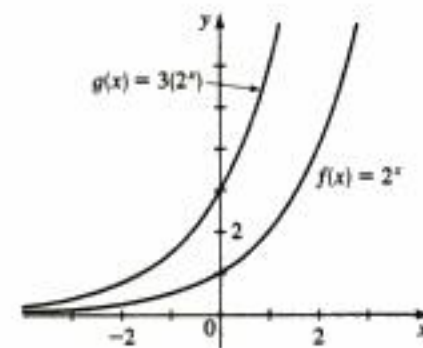

45.

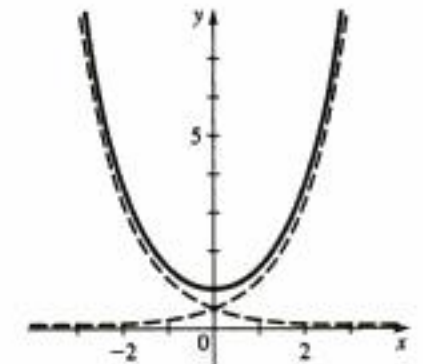

15. $f(x) = 3^x$ 17. $f(x) = (\frac{1}{4})^x$ 19. III 21. I 23. II

25. $\mathbb{R}, (-\infty, 0), y = 0$

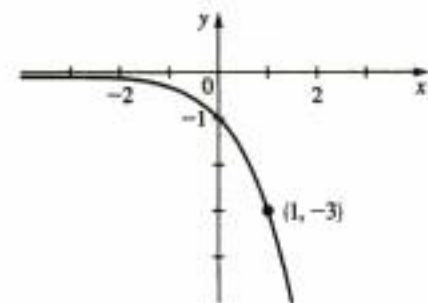

27. $\mathbb{R}, (-3, \infty), y = -3$

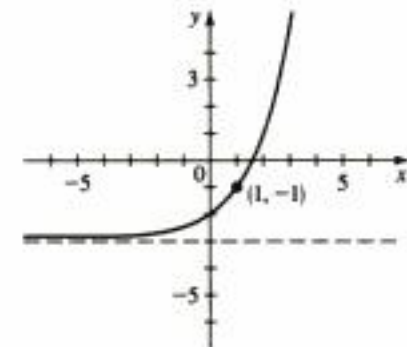

b) La gráfica de g tiene mayor pendiente que la de f .

51. a)

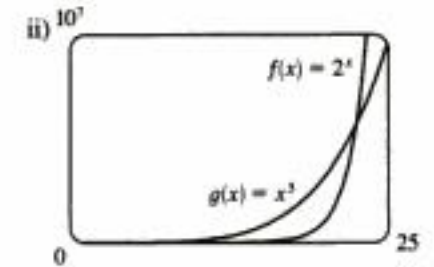
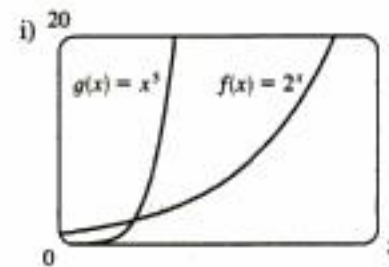

29. $\mathbb{R}, (4, \infty), y = 4$

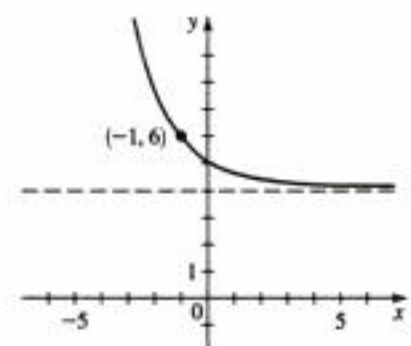

31. $\mathbb{R}, (0, \infty), y = 0$

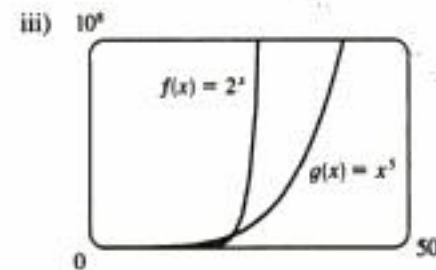
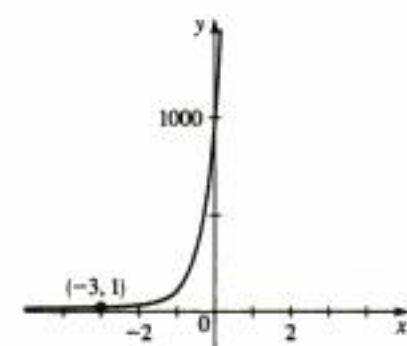

La gráfica de f se incrementa en última instancia mucho más rápido que g .

b) 1.2, 22.4

53.

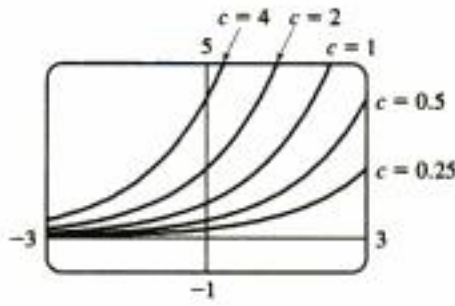

A medida que el valor de c es mayor, con mayor rapidez se incrementa la gráfica.

55.

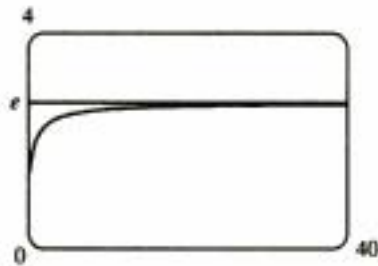

57. a)

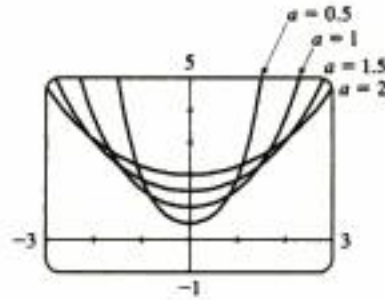

b) Entre más grande es el valor de a , más ancha es la gráfica.

59.

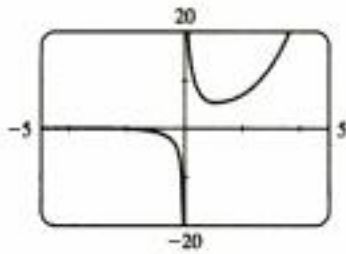

asíntota vertical $x = 0$
asíntota horizontal $y = 0$, sólo lado izquierdo

61. Mínimo local $\approx (0.27, 1.75)$
 63. a) Creciente en $(-\infty, 1.00]$, decreciente en $[1.00, \infty)$
 b) $(-\infty, 0.37]$ 65. a) 13 kg b) 6.6 kg
 67. a) 0 b) 50.6 pies/s, 69.2 pies/s
 c)

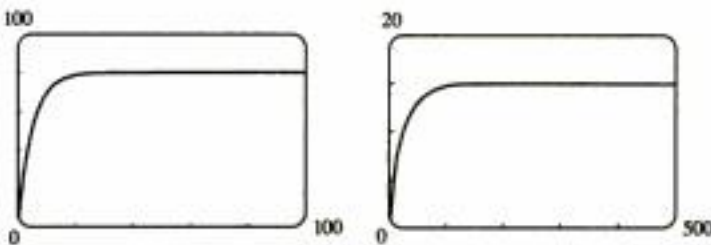

- d) 80 pies/s d) 15 lb; sí
 69. a) 100 b) 482, 999, 1168 c) 1200
 71. 1.6 pies
 73. \$5203.71, \$5415.71, \$5636.36, \$5865.99, \$6104.98, \$6353.71
 75. a) \$16 288.95 b) \$26 532.98 c) \$43 219.42
 77. a) \$4615.87 b) \$4658.91 c) \$4697.04
 d) \$4703.11 e) \$4704.68 f) \$4704.93
 g) \$4704.94 79. i) 81. a) \$7678.96 b) \$67 121.04

Sección 4.2 ■ página 349

1. Forma logarítmica	Forma exponencial
$\log_8 8 = 1$	$8^1 = 8$
$\log_8 64 = 2$	$8^2 = 64$
$\log_8 4 = \frac{2}{3}$	$8^{2/3} = 4$
$\log_8 512 = 3$	$8^3 = 512$
$\log_8 \frac{1}{8} = -1$	$8^{-1} = \frac{1}{8}$
$\log_8 \frac{1}{64} = -2$	$8^{-2} = \frac{1}{64}$

3. a) $5^2 = 25$ b) $5^0 = 1$ 5. a) $8^{1/3} = 2$ b) $2^{-3} = \frac{1}{8}$
 7. a) $e^x = 5$ b) $e^5 = y$ 9. a) $\log_5 125 = 3$
 b) $\log_{10} 0.0001 = -4$ 11. a) $\log_8 \frac{1}{8} = -1$ b) $\log_2 \frac{1}{8} = -3$
 13. a) $\ln 2 = x$ b) $\ln y = 3$ 15. a) 1 b) 0 c) 2
 17. a) 2 b) 2 c) 10 19. a) -3 b) $\frac{1}{2}$ c) -1
 21. a) 37 b) 8 c) $\sqrt{5}$ 23. a) $-\frac{2}{3}$ b) 4 c) -1
 25. a) 32 b) 4 27. a) 5 b) 27 29. a) 100 b) 25
 31. a) 2 b) 4 33. a) 0.3010 b) 1.5465 c) -0.1761
 35. a) 1.6094 b) 3.2308 c) 1.0051 37. $y = \log_5 x$
 39. $y = \log_9 x$ 41. II 43. III 45. VI

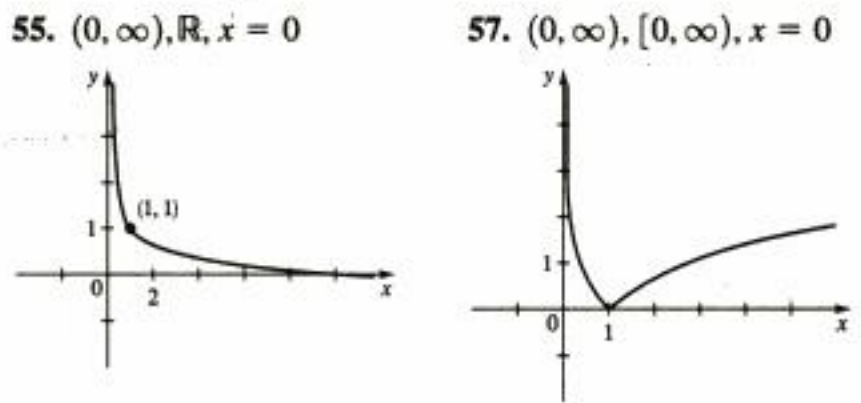
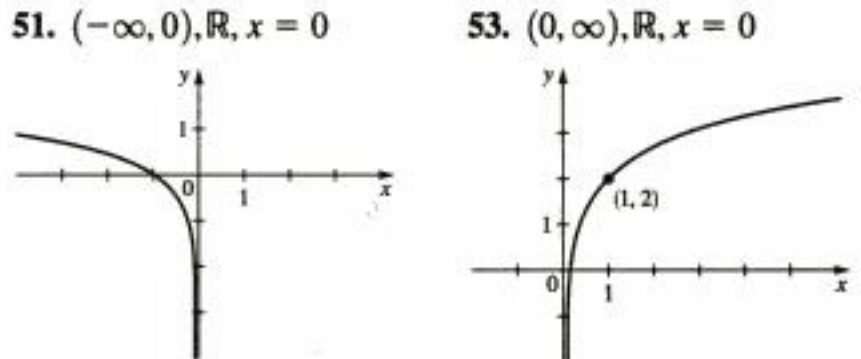
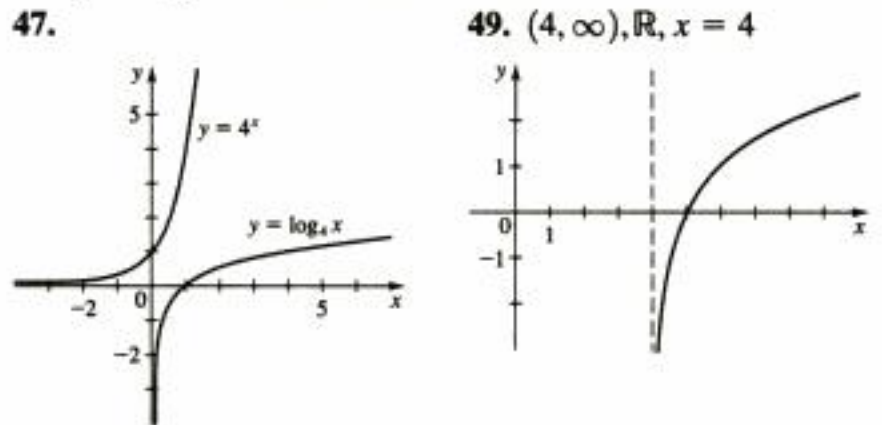

59. $(-3, \infty)$ 61. $(-\infty, -1) \cup (1, \infty)$ 63. $(0, 2)$

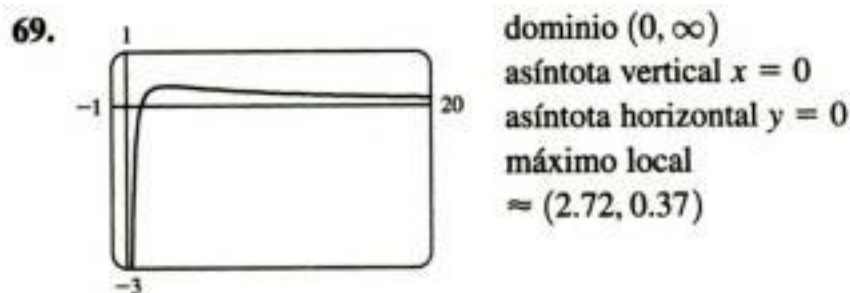
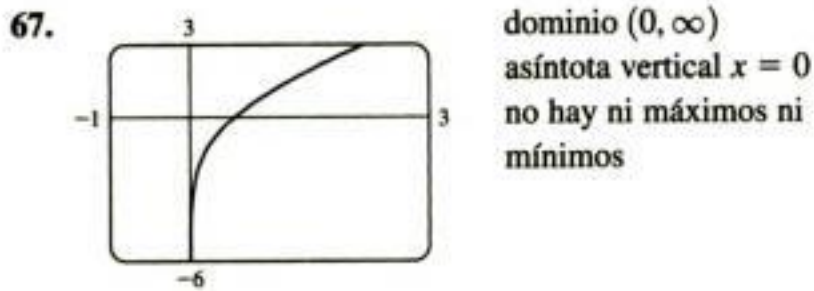
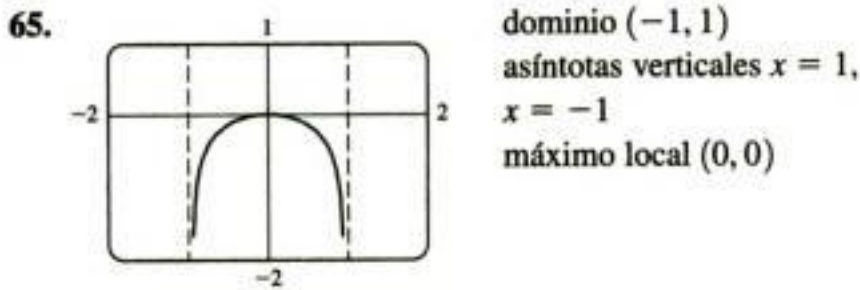

71. La gráfica de f crece más lentamente que g

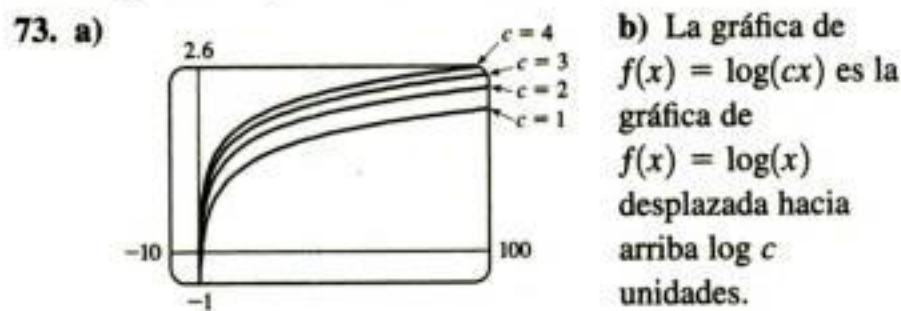

75. a) $(1, \infty)$ b) $f^{-1}(x) = 10^{2x}$

77. a) $f^{-1}(x) = \log_2\left(\frac{x}{1-x}\right)$ b) $(0, 1)$ 79. 2602 años

81. 11.5 años, 9.9 años, 8.7 años 83. 5.32, 4.32

Sección 4.3 ■ página 356

1. $\frac{3}{2}$ 3. 2 5. 3 7. 3 9. 200 11. 4
13. $1 + \log_2 x$ 15. $\log_2 x + \log_2(x-1)$
17. $10 \log 6$ 19. $\log_2 A + 2 \log_2 B$
21. $\log_3 x + \frac{1}{2} \log_3 y$ 23. $\frac{1}{3} \log_5(x^2 + 1)$
25. $\frac{1}{2}(\ln a + \ln b)$ 27. $3 \log x + 4 \log y - 6 \log z$
29. $\log_2 x + \log_2(x^2 + 1) - \frac{1}{2} \log_2(x^2 - 1)$
31. $\ln x + \frac{1}{2}(\ln y - \ln z)$ 33. $\frac{1}{4} \log(x^2 + y^2)$
35. $\frac{1}{2}[\log(x^2 + 4) - \log(x^2 + 1) - 2 \log(x^3 - 7)]$
37. $3 \ln x + \frac{1}{2} \ln(x-1) - \ln(3x+4)$ 39. $\log_3 160$
41. $\log_2(AB/C^2)$ 43. $\log\left(\frac{x^4(x-1)^2}{\sqrt{x^2+1}}\right)$ 45. $\ln(5x^2(x^2+5)^3)$
47. $\log\left(\sqrt[3]{2x+1} \sqrt{(x-4)/(x^4-x^2-1)}\right)$ 49. 2.321928

51. 2.523719 53. 0.493008 55. 3.482892

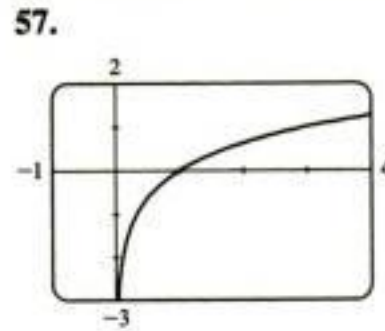

63. a) $P = c/W^k$ b) 1866, 64

65. a) $M = -2.5 \log B + 2.5 \log B_0$

Sección 4.4 ■ página 366

1. 1.3979 3. -0.9730 5. -0.5850 7. 1.2040
9. 0.0767 11. 0.2524 13. 1.9349 15. -43.0677
17. 2.1492 19. 6.2126 21. -2.9469 23. -2.4423
25. 14.0055 27. ± 1 29. $0, \frac{4}{3}$ 31. $\ln 2 \approx 0.6931, 0$
33. $\frac{1}{2} \ln 3 \approx 0.5493$ 35. $e^{10} \approx 22026$ 37. 0.01 39. $\frac{95}{3}$
41. $3 - e^2 \approx -4.3891$ 43. 5 45. 5 47. $\frac{13}{12}$ 49. 6
51. $\frac{3}{2}$ 53. $1/\sqrt{5} \approx 0.4472$ 55. 2.21 57. 0.00, 1.14
59. -0.57 61. 0.36 63. $2 < x < 4$ o $7 < x < 9$
65. $\log 2 < x < \log 5$ 67. a) \$6435.09 b) 8.24 años
69. 6.33 años 71. 8.15 años 73. 8.30%
75. 13 días 77. a) 7337 b) 1.73 años
79. a) $P = P_0 e^{-kt}$ b) 56.47 kPa
81. a) $t = -\frac{5}{13} \ln(1 - \frac{13}{60} I)$ b) 0.218 s

Sección 4.5 ■ página 379

1. a) 500 b) 45% c) 1929 d) 6.66 h
3. a) $n(t) = 18000e^{0.08t}$ b) 34,137

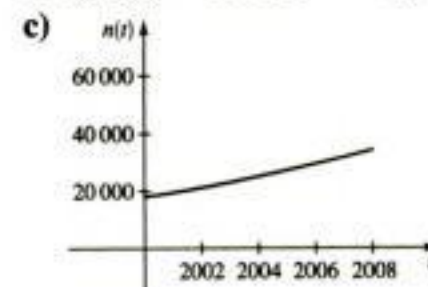

5. a) $n(t) = 112000e^{0.04t}$ b) Alrededor de 142 000
c) 2008
7. a) 20 000 b) $n(t) = 20000e^{0.1096t}$
c) Alrededor de 48 000 d) 2010
9. a) $n(t) = 8600e^{0.1508t}$ b) Alrededor de 11 600
c) 4.6 h
11. a) 2029 b) 2049 13. 22.85 h
15. a) $n(t) = 10e^{-0.0231t}$ b) 1.6 g c) 70 años
17. 18 años 19. 149 h 21. 3560 años
23. a) 210°F b) 153°F c) 28 min
25. a) 137°F b) 116 min
27. a) 2.3 b) 3.5 c) 8.3
29. a) 10^{-3} M b) 3.2×10^{-7} M
31. $4.8 \leq \text{pH} \leq 6.4$ 33. $\log 20 \approx 1.3$

35. El doble de intenso 37. 8.2
 39. $6.3 \times 10^{-3} \text{ W/m}^2$ 41. b) 106 dB

Capítulo 4 Repaso ■ página 383

1. $\mathbb{R}, (0, \infty), y = 0$ 3. $\mathbb{R}, (3, \infty), y = 3$

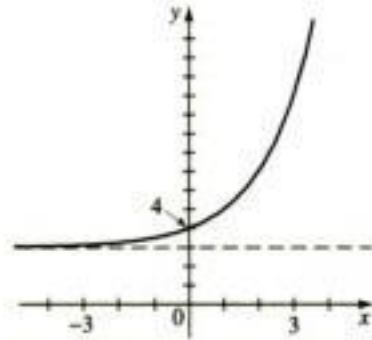
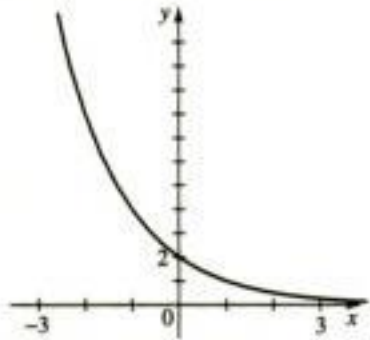

5. $(1, \infty), \mathbb{R}, x = 1$ 7. $(0, \infty), \mathbb{R}, x = 0$

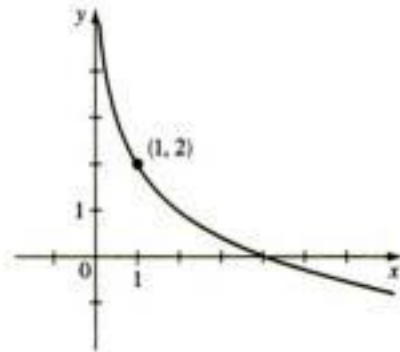
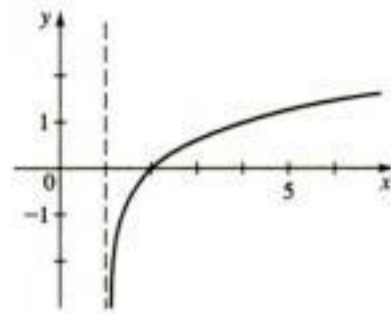

9. $\mathbb{R}, (-1, \infty), y = -1$ 11. $(0, \infty), \mathbb{R}, x = 0$

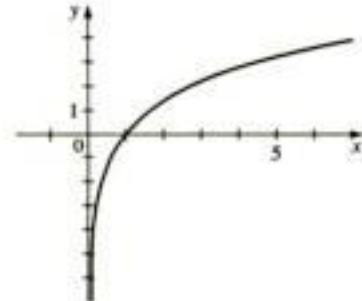
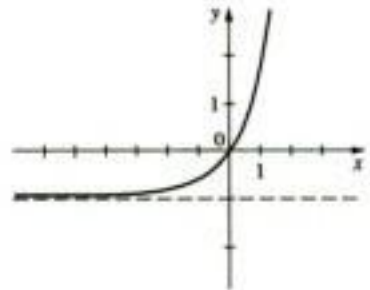

13. $(-\infty, \frac{1}{2})$ 15. $(-\infty, -2) \cup (2, \infty)$ 17. $2^{10} = 1024$
 19. $10^y = x$ 21. $\log_2 64 = 6$ 23. $\log 74 = x$
 25. 7 27. 45 29. 6 31. -3 33. $\frac{1}{2}$ 35. 2 37. 92
 39. $\frac{2}{3}$ 41. $\log A + 2 \log B + 3 \log C$
 43. $\frac{1}{2}[\ln(x^2 - 1) - \ln(x^2 + 1)]$
 45. $2 \log_5 x + \frac{3}{2} \log_5(1 - 5x) - \frac{1}{2} \log_5(x^3 - x)$
 47. $\log 96$ 49. $\log_2 \left(\frac{(x-y)^{3/2}}{(x^2+y^2)^2} \right)$ 51. $\log \left(\frac{x^2 - 4}{\sqrt{x^2 + 4}} \right)$
 53. -15 55. $\frac{1}{3}(5 - \log_5 26) \approx 0.99$ 57. $\frac{4}{3} \ln 10 \approx 3.07$
 59. 3 61. -4, 2 63. 0.430618 65. 2.303600

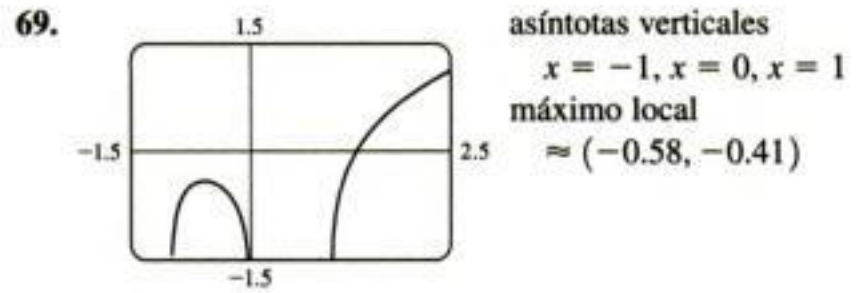
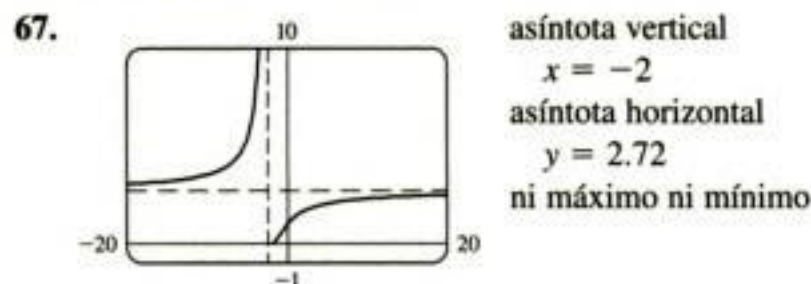

71. 2.42 73. $0.16 < x < 3.15$
 75. Creciente en $(-\infty, 0]$ y $[1.10, \infty)$, decreciente en $[0, 1.10]$
 77. 1.953445 79. $\log_4 258$
 81. a) \$16081.15 b) \$16178.18 c) \$16197.64
 d) \$16198.31
 83. a) $n(t) = 30e^{0.15t}$ b) 55 c) 19 años
 85. a) 9.97 mg b) 1.39×10^5 años
 87. a) $n(t) = 150e^{-0.0004359t}$ b) 97.0 mg c) 2520 años
 89. a) $n(t) = 1500e^{0.1515t}$ b) 7940
 91. 7.9, básica 93. 8.0

Capítulo 4 Evaluación ■ página 385

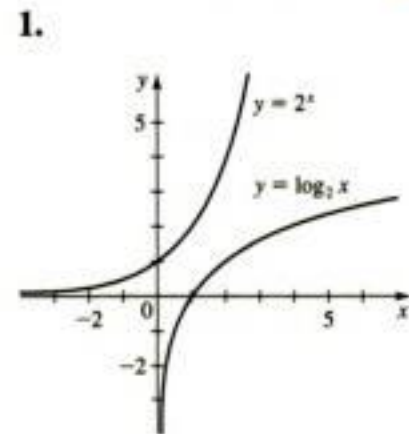

3. a) $\frac{3}{2}$ b) 3 c) $\frac{2}{3}$ d) 2
 5. $\ln \left(\frac{x\sqrt{3-x^4}}{(x^2+1)^2} \right)$
 7. a) $n(t) = 1000e^{2.07944t}$ b) 22627 c) 1.3 h

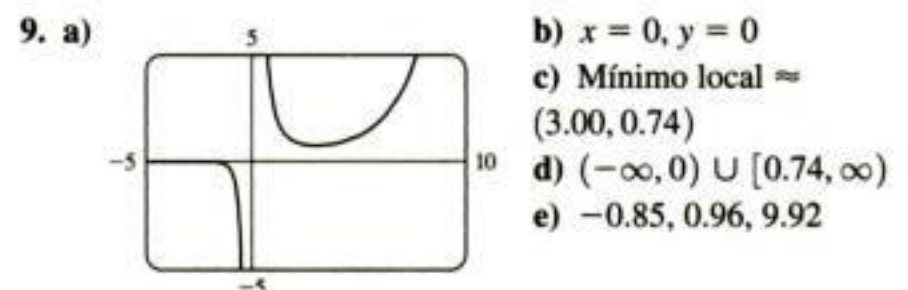
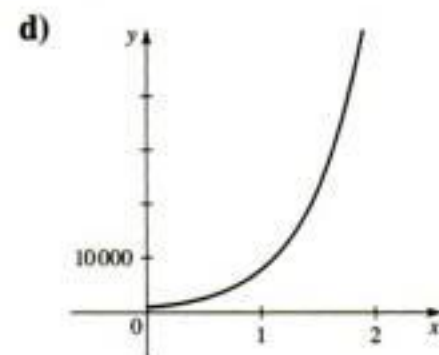

17. a) $\sqrt{2}/2$ b) $-\sqrt{2}$ c) -1
 19. a) -1 b) 1 c) -1 21. a) 0 b) 1 c) 0
 23. $\sin 0 = 0$, $\cos 0 = 1$, $\tan 0 = 0$, $\sec 0 = 1$,
 otras no están definidas
 25. $\sin \pi = 0$, $\cos \pi = -1$, $\tan \pi = 0$, $\sec \pi = -1$,
 otras no están definidas
 27. $\frac{4}{3}, \frac{3}{3}, \frac{4}{3}$ 29. $-\sqrt{11}/4, \sqrt{5}/4, -\sqrt{55}/5$
 31. $\sqrt{13}/7, -6/7, -\sqrt{13}/6$ 33. $-\frac{12}{13}, -\frac{5}{13}, \frac{12}{5}$
 35. $\frac{21}{29}, -\frac{20}{29}, -\frac{21}{20}$ 37. a) 0.8 b) 0.84147
 39. a) 0.9 b) 0.93204 41. a) 1 b) 1.02964
 43. a) -0.6 b) -0.57482 45. Negativo
 47. Negativo 49. II 51. II 53. $\sin t = \sqrt{1 - \cos^2 t}$
 55. $\tan t = (\sin t)/\sqrt{1 - \sin^2 t}$ 57. $\sec t = -\sqrt{1 + \tan^2 t}$
 59. $\tan t = \sqrt{\sec^2 t - 1}$ 61. $\tan^2 t = (\sin^2 t)/(1 - \sin^2 t)$
 63. $\cos t = -\frac{4}{5}$, $\tan t = -\frac{3}{4}$, $\csc t = \frac{5}{3}$, $\sec t = -\frac{5}{4}$, $\cot t = -\frac{4}{3}$
 65. $\sin t = -2\sqrt{2}/3$, $\cos t = \frac{1}{3}$, $\tan t = -2\sqrt{2}$,
 $\csc t = -\frac{3}{4}\sqrt{2}$, $\cot t = -\sqrt{2}/4$
 67. $\sin t = -\frac{3}{5}$, $\cos t = \frac{4}{5}$, $\csc t = -\frac{5}{3}$, $\sec t = \frac{5}{4}$, $\cot t = -\frac{4}{3}$
 69. $\cos t = -\sqrt{15}/4$, $\tan t = \sqrt{15}/15$, $\csc t = -4$,
 $\sec t = -4\sqrt{15}/15$, $\cot t = \sqrt{15}$
 71. Impar 73. Impar 75. Par 77. Ninguna de los dos
 79. $y(0) = 4$, $y(0.25) = -2.828$, $y(0.50) = 0$,
 $y(0.75) = 2.828$, $y(1.00) = -4$, $y(1.25) = 2.828$
 81. a) 0.49870 amp b) -0.17117 amp

Sección 5.3 ■ página 429

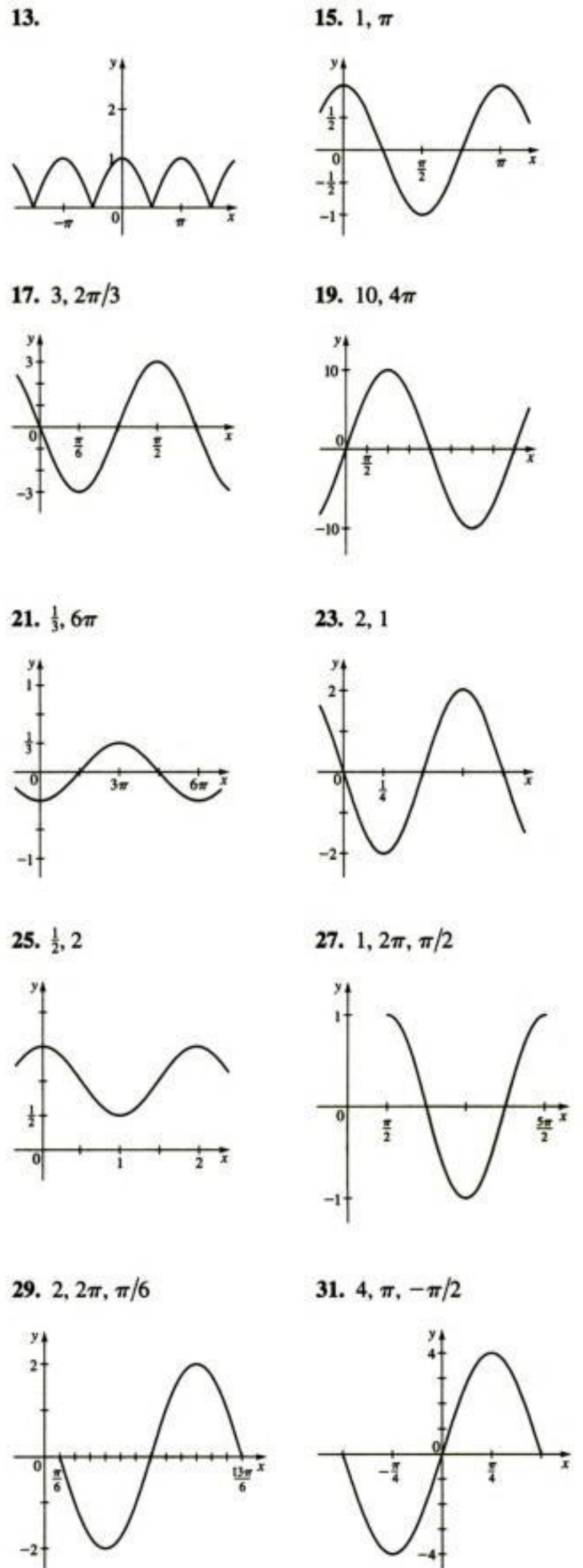
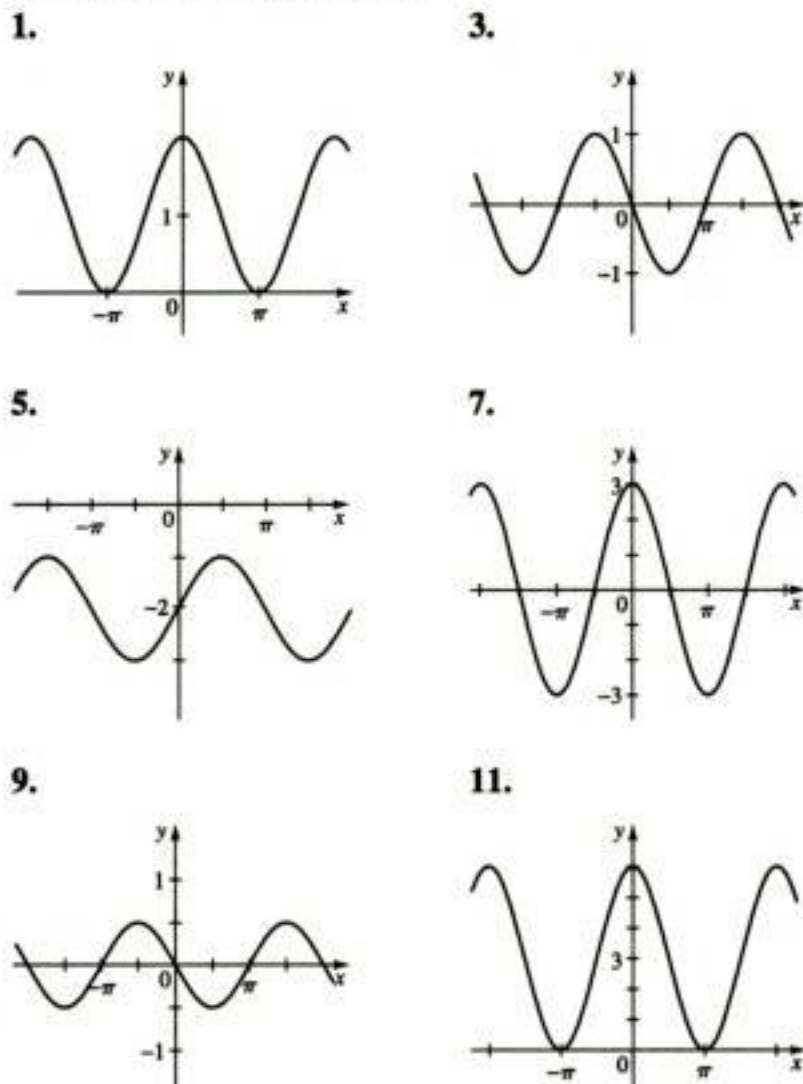

33. $5, 2\pi/3, \pi/12$

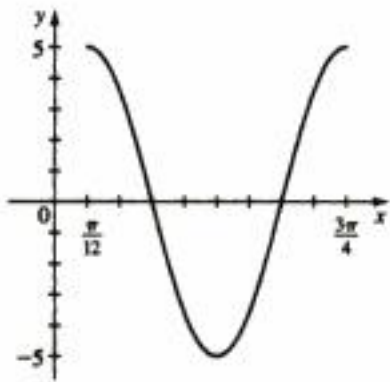

35. $\frac{1}{2}, \pi, \pi/6$

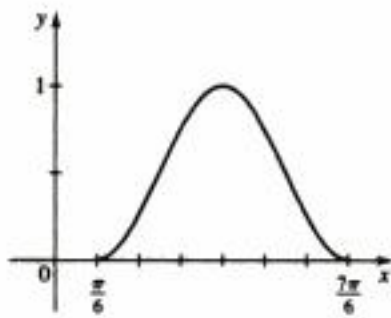

37. $3, 2, -\frac{1}{2}$

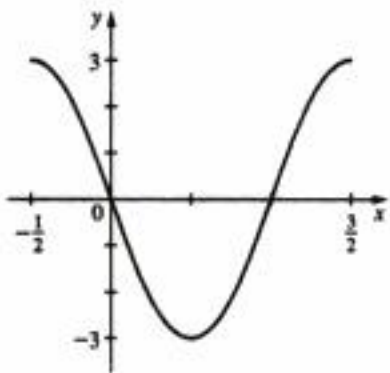

39. $1, 2\pi/3, -\pi/3$

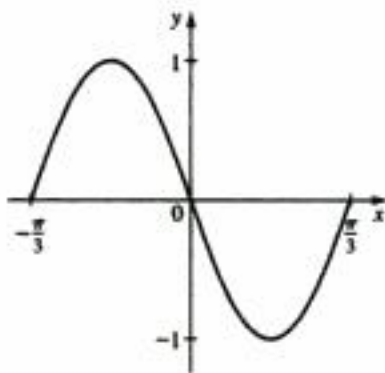

41. a) $4, 2\pi, 0$ b) $y = 4 \text{ sen } x$

43. a) $\frac{3}{2}, \frac{2\pi}{3}, 0$ b) $y = \frac{3}{2} \cos 3x$

45. a) $\frac{1}{2}, \pi, -\frac{\pi}{3}$ b) $y = -\frac{1}{2} \cos 2(x + \pi/3)$

47. a) $4, \frac{3}{2}, -\frac{1}{2}$ b) $y = 4 \text{ sen } \frac{4\pi}{3}(x + \frac{1}{2})$

49. **51.**

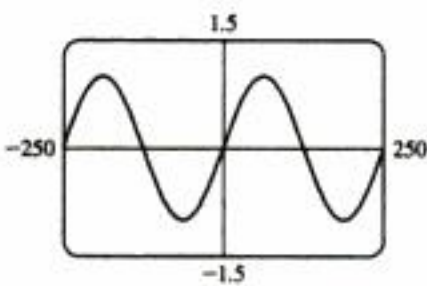
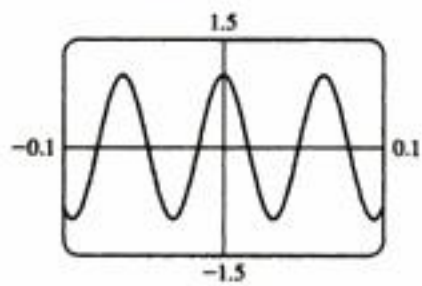

53.

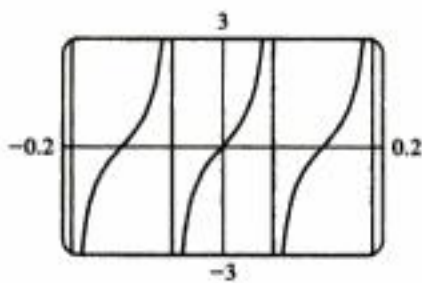

55.

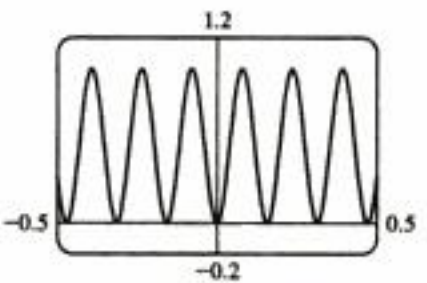

57.

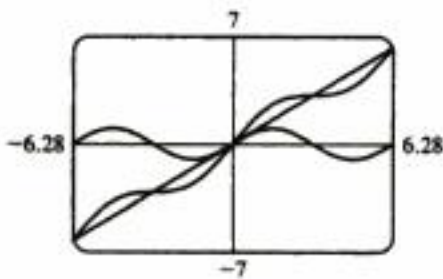

59. $y = x^2 \text{ sen } x$ es una curva seno que queda entre las gráficas de $y = x^2$ y $y = -x^2$

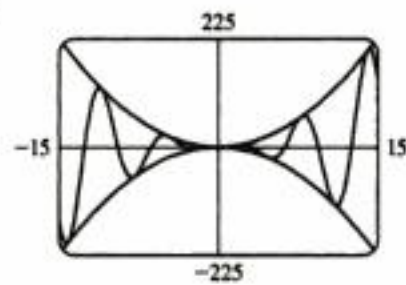

61. $y = \sqrt{x} \text{ sen } 5\pi x$ es una curva seno que se ubica entre las gráficas de $y = \sqrt{x}$ y $y = -\sqrt{x}$

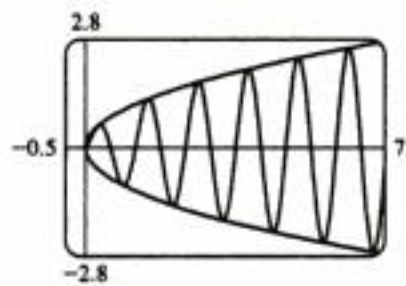

63. $y = \cos 3\pi x \cos 21\pi x$ es una curva coseno que está entre las gráficas de $y = \cos 3\pi x$ y $y = -\cos 3\pi x$

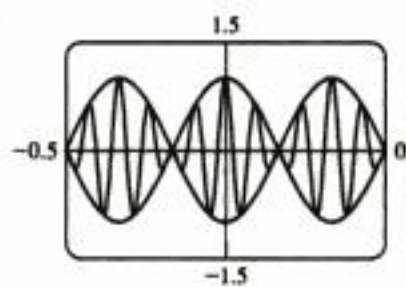

65. Valor máximo 1.76 cuando $x \approx 0.94$, valor mínimo -1.76 cuando $x \approx -0.94$ (Los mismos valores máximo y mínimo se presentan en una cantidad infinita de otros valores de x .)

67. Valor máximo 3.00 cuando $x \approx 1.57$, valor mínimo -1.00 cuando $x \approx -1.57$ (Los mismos valores máximo y mínimo se encuentran en una cantidad infinita de otros valores de x .)

69. 1.16 71. 0.34, 2.80

73. a) Impar b) $0, \pm 2\pi, \pm 4\pi, \pm 6\pi, \dots$

c) d) $f(x)$ se aproxima a 0 e) $f(x)$ se aproxima a 0

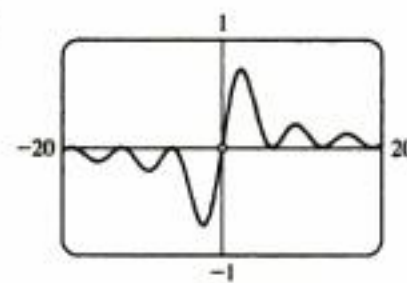

75. a) 20 s b) 6 pies

77. a) $\frac{1}{80}$ min b) 80

c) d) $\frac{140}{90}$; es más alta que lo normal

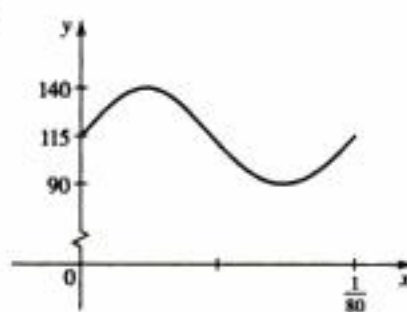

Sección 5.4 ■ página 441

1. II 3. VI 5. IV

23. a) $y = 0.3e^{-0.2t} \text{sen}(40\pi t)$

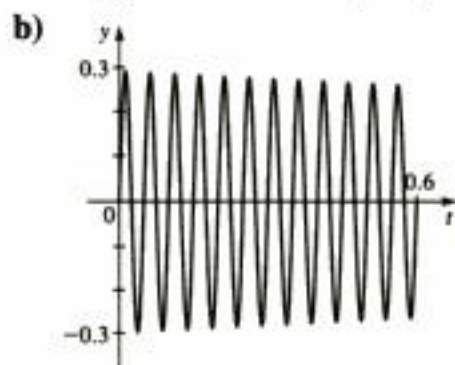

25. a) 10 ciclos por minuto

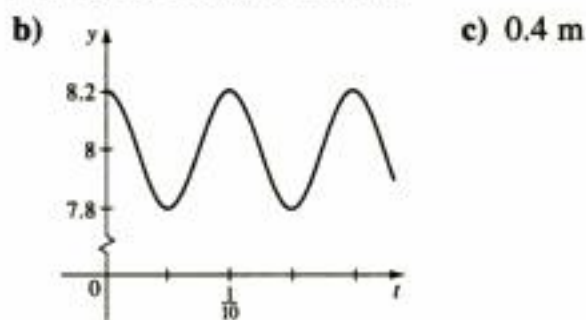

27. a) 8900 b) alrededor de 3.14 años

29. $d(t) = 5 \text{sen}(5\pi t)$

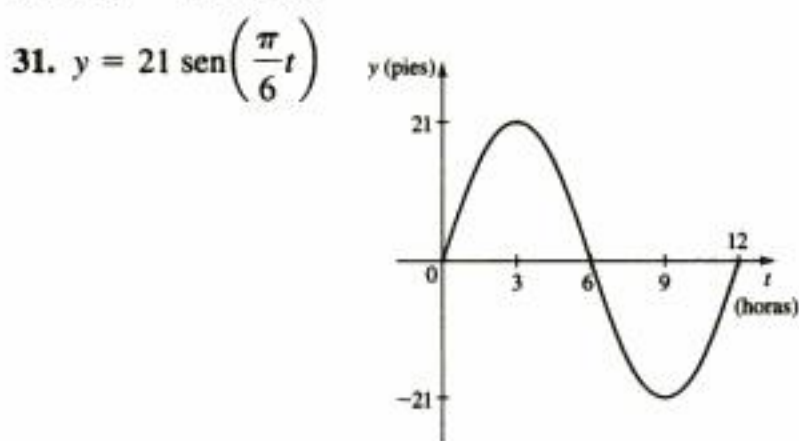

33. $y = 5 \cos(2\pi t)$ 35. $y = 11 + 10 \text{sen}\left(\frac{\pi t}{10}\right)$

37. $y = 3.8 + 0.2 \text{sen}\left(\frac{\pi}{5}t\right)$

39. $E(t) = 310 \cos(200\pi t)$, 219.2 V

41. a) 45 V b) 40 c) 40 d) $E(t) = 45 \cos(80\pi t)$

43. $f(t) = e^{-0.9t} \text{sen } \pi t$ 45. $e = \frac{1}{3} \ln 4 \approx 0.46$

Capítulo 5 Repaso ■ página 455

1. b) $\frac{1}{2}, -\sqrt{3}/2, -\sqrt{3}/3$

3. a) $\pi/3$ b) $(-\frac{1}{2}, \sqrt{3}/2)$

c) $\text{sen } t = \sqrt{3}/2, \text{cos } t = -\frac{1}{2}, \text{tan } t = -\sqrt{3}, \text{csc } t = 2\sqrt{3}/3, \text{sec } t = -2, \text{cot } t = -\sqrt{3}/3$

5. a) $\pi/4$ b) $(-\sqrt{2}/2, -\sqrt{2}/2)$

c) $\text{sen } t = -\sqrt{2}/2, \text{cos } t = -\sqrt{2}/2, \text{tan } t = 1, \text{csc } t = -\sqrt{2}, \text{sec } t = -\sqrt{2}, \text{cot } t = 1$

7. a) $\sqrt{2}/2$ b) $-\sqrt{2}/2$ 9. a) 0.89121 b) 0.45360

11. a) 0 b) Indefinida 13. a) Indefinida b) 0

15. a) $-\sqrt{3}/3$ b) $-\sqrt{3}$

17. $(\text{sen } t)/(1 - \text{sen}^2 t)$ 19. $(\text{sen } t)/\sqrt{1 - \text{sen}^2 t}$

21. $\text{tan } t = -\frac{5}{12}, \text{csc } t = \frac{13}{5}, \text{sec } t = -\frac{13}{12}, \text{cot } t = -\frac{12}{5}$

23. $\text{sen } t = 2\sqrt{5}/5, \text{cos } t = -\sqrt{5}/5,$

$\text{tan } t = -2, \text{sec } t = -\sqrt{5}$

25. $(16 - \sqrt{17})/4$ 27. 3

29. a) 10, 4π , 0

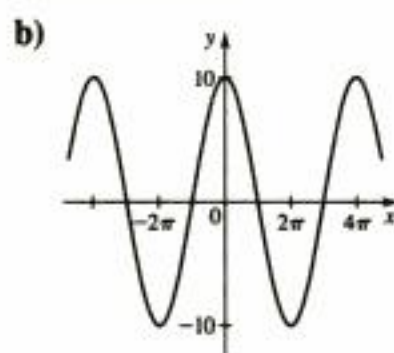

31. a) 1, 4π , 0

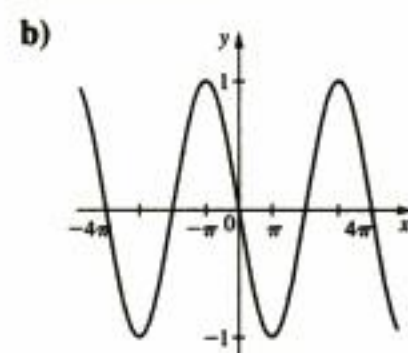

33. a) 3, π , 1

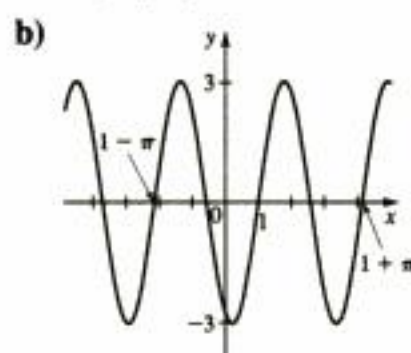

35. a) 1, 4, $-\frac{1}{3}$

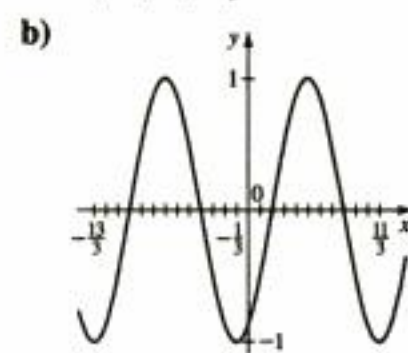

37. $y = 5 \text{sen } 4x$

41. π

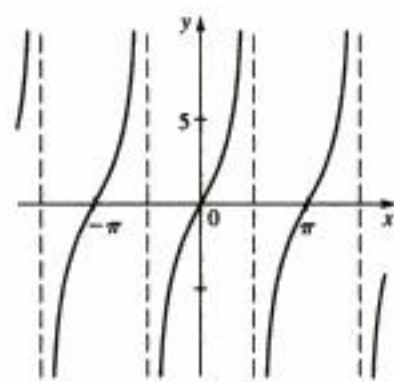

39. $y = \frac{1}{2} \text{sen } 2\pi(x + \frac{1}{3})$

43. π

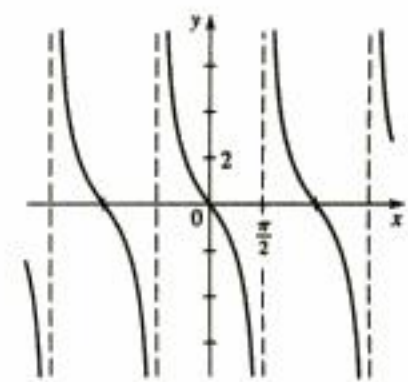

45. π

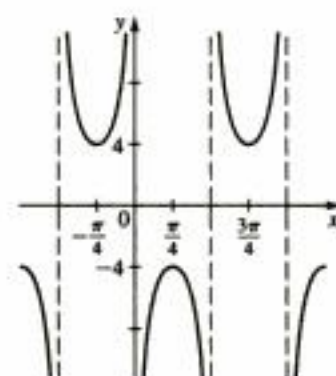

47. 2π

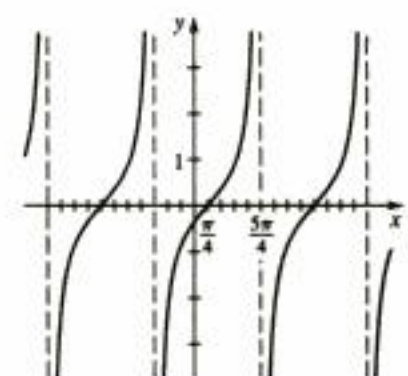

49. a)

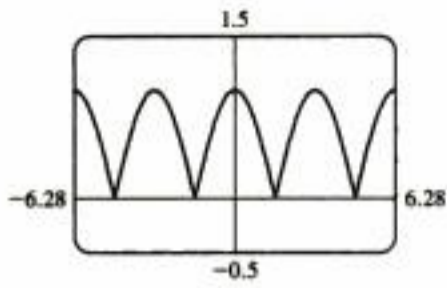

- b) Periodo π
c) Par

51. a)

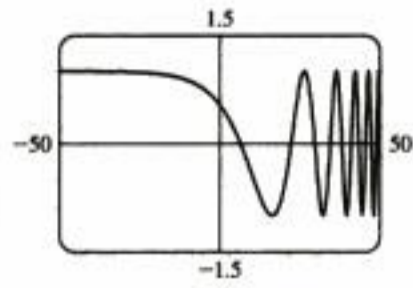

- b) No periódica
c) Ninguno de los dos

7. a) $2, 4\pi, \pi/3$

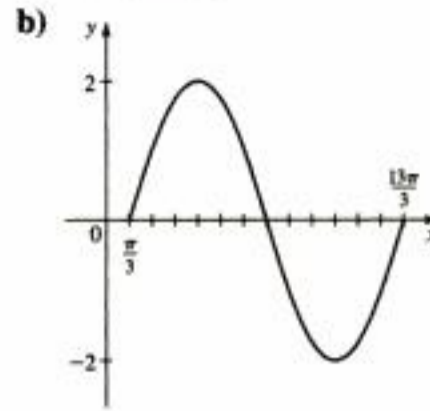

9. $\pi/2$

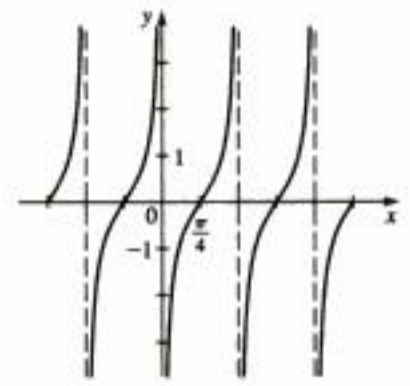

53. a)

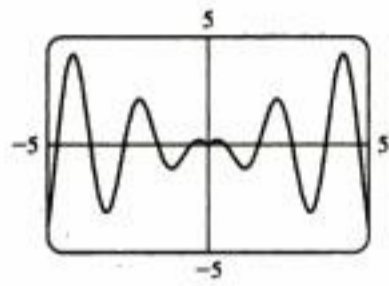

- b) No periódica
c) Par

11. a)

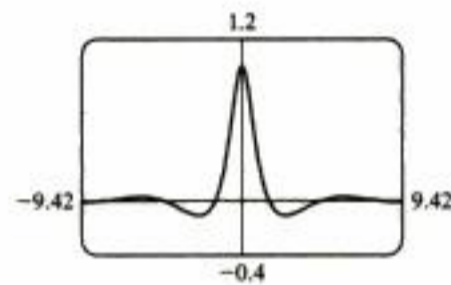

b) Par

- c) Valor mínimo -0.11 cuando $x \approx \pm 2.54$, valor máximo 1 cuando $x = 0$

55.

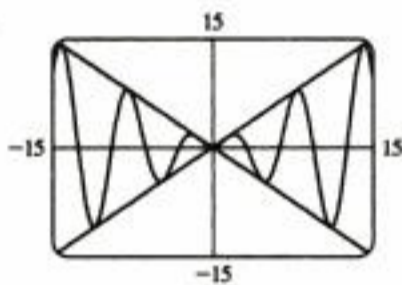

$y = x \text{ sen } x$ es una función seno cuya gráfica queda entre la de $y = x$ y $y = -x$

57.

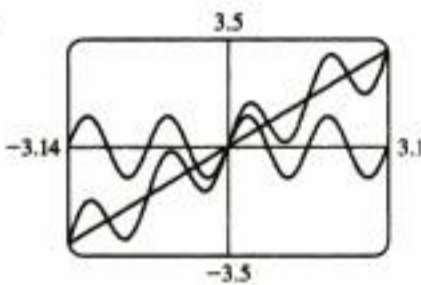

Las gráficas se relacionan mediante la adición gráfica.

59. 1.76, -1.76 61. 0.30, 2.84

63. a) Impar b) $0, \pm\pi, \pm 2\pi, \dots$

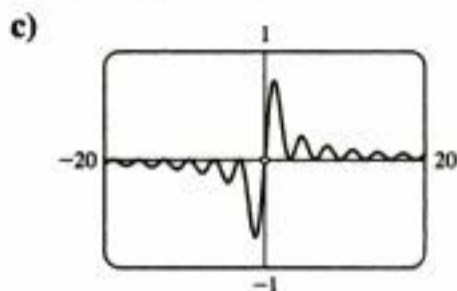

- d) $f(x)$ se aproxima a 0
e) $f(x)$ se aproxima a 0

65. $y = 50 \cos(16\pi t)$ 67. $y = 4 \cos(\frac{\pi}{6} t)$

Capítulo 5 Evaluación ■ página 458

1. $y = -\frac{5}{6}$ 3. a) $-\frac{1}{2}$ b) $-\sqrt{2}/2$ c) $\sqrt{3}$ d) -1 5. $-\frac{2}{13}$

13. $y = 16e^{-0.1t} \cos 24\pi t$

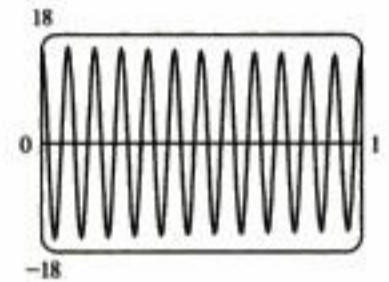

Enfoque en el modelado ■ página 463

1. a) y c)

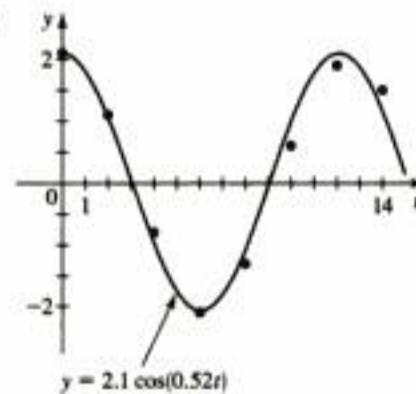

b) $y = 2.1 \cos(0.52t)$

d) $y = 2.05 \text{ sen}(0.50t + 1.55) - 0.01$ e) La fórmula de d) se reduce a $y = 2.05 \cos(0.50t - 0.02) - 0.01$. Igual que b), con una cifra decimal.

3. a) y c)

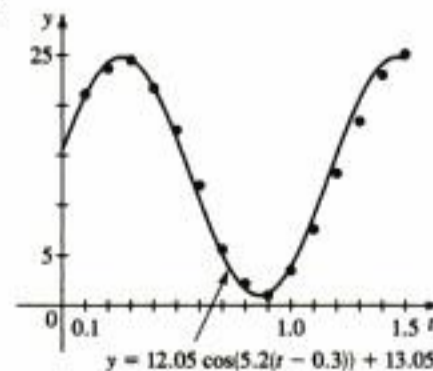

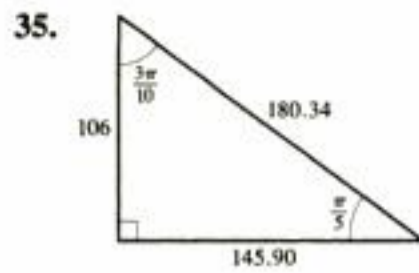
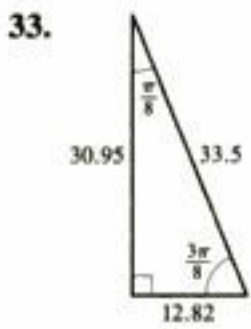

37. $\sin \theta \approx 0.45$, $\cos \theta \approx 0.89$, $\tan \theta = 0.50$, $\csc \theta \approx 2.24$,
 $\sec \theta \approx 1.12$, $\cot \theta = 2.00$ 39. 230.9 41. 63.7
 43. $x = 10 \tan \theta \sin \theta$ 45. 1026 pies
 47. a) 2100 millas b) No 49. 19 pies 51. 38.7°
 53. 345 pies 55. 415 pies, 152 pies 57. 2570 pies
 59. 5808 pies 61. 91.7 millones de millas
 63. 3960 millas 65. 0.723 AU

Sección 6.3 ■ página 495

1. a) 30° b) 30° c) 30° 3. a) 45° b) 90° c) 75°
 5. a) $\pi/4$ b) $\pi/6$ c) $\pi/3$ 7. a) $2\pi/7$ b) 0.4π c) 1.4
 9. $\frac{1}{2}$ 11. $-\sqrt{2}/2$ 13. $-\sqrt{3}$ 15. 1 17. $-\sqrt{3}/2$
 19. $\sqrt{3}/3$ 21. $\sqrt{3}/2$ 23. -1 25. $\frac{1}{2}$ 27. 2
 29. -1 31. No definido 33. III 35. IV
 37. $\tan \theta = -\sqrt{1 - \cos^2 \theta} / \cos \theta$
 39. $\cos \theta = \sqrt{1 - \sin^2 \theta}$ 41. $\sec \theta = -\sqrt{1 + \tan^2 \theta}$
 43. $\cos \theta = -\frac{4}{5}$, $\tan \theta = -\frac{3}{4}$, $\csc \theta = \frac{5}{3}$, $\sec \theta = -\frac{5}{4}$,
 $\cot \theta = -\frac{4}{3}$
 45. $\sin \theta = -\frac{3}{5}$, $\cos \theta = \frac{4}{5}$, $\csc \theta = -\frac{5}{3}$, $\sec \theta = \frac{5}{4}$, $\cot \theta = -\frac{4}{3}$
 47. $\sin \theta = \frac{1}{2}$, $\cos \theta = \sqrt{3}/2$, $\tan \theta = \sqrt{3}/3$,
 $\sec \theta = 2\sqrt{3}/3$, $\cot \theta = \sqrt{3}$
 49. $\sin \theta = 3\sqrt{5}/7$, $\tan \theta = -3\sqrt{5}/2$, $\csc \theta = 7\sqrt{5}/15$,
 $\sec \theta = -\frac{7}{2}$, $\cot \theta = -2\sqrt{5}/15$
 51. a) $\sqrt{3}/2, \sqrt{3}$ b) $\frac{1}{2}, \sqrt{3}/4$ c) $\frac{3}{4}, 0.88967$
 53. 19.1 55. 66.1° 57. $(4\pi/3) - \sqrt{3} \approx 2.46$
 61. b)

θ	20°	60°	80°	85°
h	1922	9145	29 944	60 351

63. a) $A(\theta) = 400 \sin \theta \cos \theta$

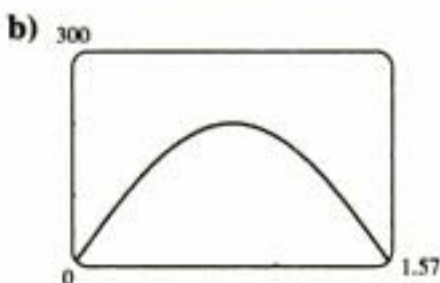

- c) ancho = profundidad ≈ 14.14 pulg.
 65. a) $9\sqrt{3}/4$ pies ≈ 3.897 pies, $\frac{9}{16}$ pies = 0.5625 pies
 b) 23.982 pies, 3.462 pies

67. a)

- b) 0.946 rad o 54°

69. 42°

Sección 6.4 ■ página 506

1. 318.8 3. 24.8 5. 44°
 7. $\angle C = 114^\circ$, $a \approx 51$, $b \approx 24$
 9. $\angle A = 44^\circ$, $\angle B = 68^\circ$, $a \approx 8.99$
 11. $\angle C = 62^\circ$, $a \approx 200$, $b \approx 242$

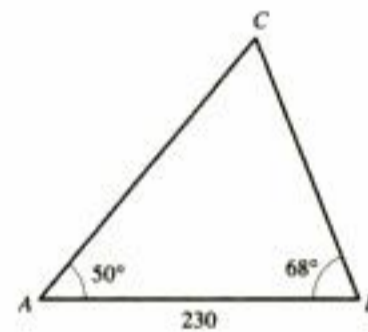

13. $\angle B = 85^\circ$, $a \approx 5$, $c \approx 9$

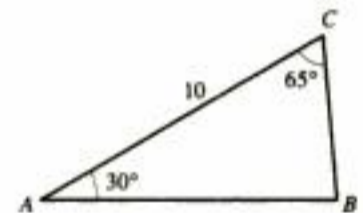

15. $\angle A = 100^\circ$, $a \approx 89$, $c \approx 71$

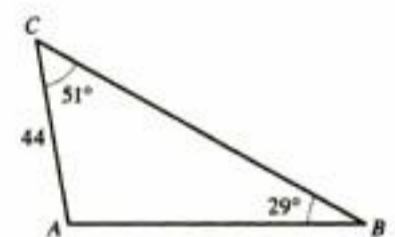

17. $\angle B \approx 30^\circ$, $\angle C \approx 40^\circ$, $c \approx 19$ 19. No hay solución
 21. $\angle A_1 \approx 125^\circ$, $\angle C_1 \approx 30^\circ$, $a_1 \approx 49$;
 $\angle A_2 \approx 5^\circ$, $\angle C_2 \approx 150^\circ$, $a_2 \approx 5.6$
 23. No hay solución
 25. $\angle A_1 \approx 57.2^\circ$, $\angle B_1 \approx 93.8^\circ$, $b_1 \approx 30.9$;
 $\angle A_2 \approx 122.8^\circ$, $\angle B_2 \approx 28.2^\circ$, $b_2 \approx 14.6$
 27. a) 91.146° b) 14.427°
 31. a) 1018 millas b) 1017 millas 33. 219 pies
 35. 55.9 m 37. 175 pies
 39. 192 m 41. 0.427 AU, 1.119 AU

Sección 6.5 ■ página 513

1. 28.9 3. 47 5. 29.89°
 7. 15 9. $\angle A \approx 39.4^\circ$, $\angle B \approx 20.6^\circ$, $c \approx 24.6$
 11. $\angle A \approx 48^\circ$, $\angle B \approx 79^\circ$, $c \approx 3.2$
 13. $\angle A \approx 50^\circ$, $\angle B \approx 73^\circ$, $\angle C \approx 57^\circ$

49. $PM = 2(1 - \text{sen}^2x) - 1 = 2 - 2\text{sen}^2x - 1 = SM$

51. $PM = \frac{1 - \cos \alpha}{\text{sen } \alpha} \cdot \frac{1 + \cos \alpha}{1 + \cos \alpha}$
 $= \frac{1 - \cos^2 \alpha}{\text{sen } \alpha(1 + \cos \alpha)} = \frac{\text{sen}^2 \alpha}{\text{sen } \alpha(1 + \cos \alpha)} = SM$

53. $PM = \frac{\text{sen}^2 \theta}{\cos^2 \theta} - \frac{\text{sen}^2 \theta \cos^2 \theta}{\cos^2 \theta}$
 $= \frac{\text{sen}^2 \theta(1 - \cos^2 \theta)}{\cos^2 \theta} = \frac{\text{sen}^2 \theta \text{sen}^2 \theta}{\cos^2 \theta} = SM$

55. $PM = \frac{\text{sen } x - 1}{\text{sen } x + 1} \cdot \frac{\text{sen } x + 1}{\text{sen } x + 1} = \frac{\text{sen}^2 x - 1}{(\text{sen } x + 1)^2} = SM$

57. $PM = \frac{\text{sen}^2 t + 2 \text{sen } t \cos t + \cos^2 t}{\text{sen } t \cos t}$
 $= \frac{\text{sen}^2 t + \cos^2 t}{\text{sen } t \cos t} + \frac{2 \text{sen } t \cos t}{\text{sen } t \cos t} = \frac{1}{\text{sen } t \cos t} + 2 = SM$

59. $PM = \frac{1 + \frac{\text{sen}^2 u}{\cos^2 u} \cdot \cos^2 u}{1 - \frac{\text{sen}^2 u}{\cos^2 u} \cdot \cos^2 u} = \frac{\cos^2 u + \text{sen}^2 u}{\cos^2 u - \text{sen}^2 u} = SM$

61. $PM = \frac{\sec x}{\sec x - \tan x} \cdot \frac{\sec x + \tan x}{\sec x + \tan x}$
 $= \frac{\sec x(\sec x + \tan x)}{\sec^2 x - \tan^2 x} = SM$

63. $PM = (\sec v - \tan v) \cdot \frac{\sec v + \tan v}{\sec v + \tan v}$
 $= \frac{\sec^2 v - \tan^2 v}{\sec v + \tan v} = SM$

65. $PM = \frac{\text{sen } x + \cos x}{\frac{1}{\cos x} + \frac{1}{\text{sen } x}} = \frac{\text{sen } x + \cos x}{\frac{\text{sen } x + \cos x}{\cos x \text{sen } x}}$
 $= (\text{sen } x + \cos x) \frac{\cos x \text{sen } x}{\text{sen } x + \cos x} = SM$

67. $PM = \frac{\frac{1}{\text{sen } x} - \frac{\cos x}{\text{sen } x}}{\frac{1}{\cos x} - 1} \cdot \frac{\text{sen } x \cos x}{\text{sen } x \cos x} = \frac{\cos x(1 - \cos x)}{\text{sen } x(1 - \cos x)}$
 $= \frac{\cos x}{\text{sen } x} = SM$

69. $PM = \frac{\text{sen}^2 u}{\cos^2 u} - \frac{\text{sen}^2 u \cos^2 u}{\cos^2 u} = \frac{\text{sen}^2 u}{\cos^2 u} (1 - \cos^2 u) = SM$

71. $PM = (\sec^2 x - \tan^2 x)(\sec^2 x + \tan^2 x) = SM$

73. $PM = \frac{\text{sen } \theta - \frac{1}{\text{sen } \theta}}{\cos \theta - \frac{\cos \theta}{\text{sen } \theta}} = \frac{\frac{\text{sen}^2 \theta - 1}{\text{sen } \theta}}{\frac{\cos \theta \text{sen } \theta - \cos \theta}{\text{sen } \theta}}$
 $= \frac{\cos^2 \theta}{\cos \theta(\text{sen } \theta - 1)} = SM$

75. $PM = \frac{-\text{sen}^2 t + \tan^2 t}{\text{sen}^2 t} = -1 + \frac{\text{sen}^2 t}{\cos^2 t} \cdot \frac{1}{\text{sen}^2 t}$
 $= -1 + \sec^2 t = SM$

77. $PM = \frac{\sec x - \tan x + \sec x + \tan x}{(\sec x + \tan x)(\sec x - \tan x)}$
 $= \frac{2 \sec x}{\sec^2 x - \tan^2 x} = SM$

79. $PM = \tan^2 x + 2 \tan x \cot x + \cot^2 x = \tan^2 x + 2 + \cot^2 x$
 $= (\tan^2 x + 1) + (\cot^2 x + 1) = SM$

81. $PM = \frac{\frac{1}{\cos u} - 1}{\frac{1}{\cos u} + 1} \cdot \frac{\cos u}{\cos u} = SM$

83. $PM = \frac{(\text{sen } x + \cos x)(\text{sen}^2 x - \text{sen } x \cos x + \cos^2 x)}{\text{sen } x + \cos x}$
 $= \text{sen}^2 x - \text{sen } x \cos x + \cos^2 x = SM$

85. $PM = \frac{1 + \text{sen } x}{1 - \text{sen } x} \cdot \frac{1 + \text{sen } x}{1 + \text{sen } x} = \frac{(1 + \text{sen } x)^2}{1 - \text{sen}^2 x}$
 $= \frac{(1 + \text{sen } x)^2}{\cos^2 x} = \left(\frac{1 + \text{sen } x}{\cos x}\right)^2 = SM$

87. $PM = \left(\frac{\text{sen } x}{\cos x} + \frac{\cos x}{\text{sen } x}\right)^4 = \left(\frac{\text{sen}^2 x + \cos^2 x}{\text{sen } x \cos x}\right)^4$
 $= \left(\frac{1}{\text{sen } x \cos x}\right)^4 = SM$

89. $\tan \theta$ 91. $\tan \theta$

93. $3 \cos \theta$

95. Sí

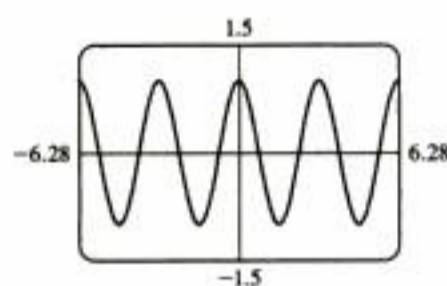

97. No

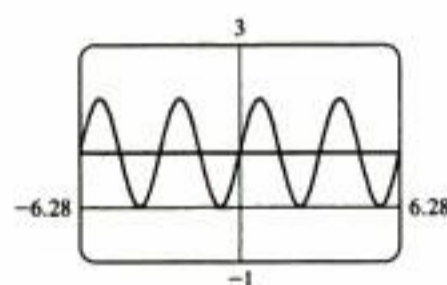

Sección 7.2 ■ página 539

1. $\frac{\sqrt{6} + \sqrt{2}}{4}$ 3. $\frac{\sqrt{2} - \sqrt{6}}{4}$ 5. $2 - \sqrt{3}$

7. $-\frac{\sqrt{6} + \sqrt{2}}{4}$ 9. $\sqrt{3} - 2$ 11. $-\frac{\sqrt{6} + \sqrt{2}}{4}$

13. $\sqrt{2}/2$ 15. $\frac{1}{2}$ 17. $\sqrt{3}$

19. $PM = \frac{\text{sen}(\frac{\pi}{2} - u)}{\cos(\frac{\pi}{2} - u)} = \frac{\text{sen } \frac{\pi}{2} \cos u - \cos \frac{\pi}{2} \text{sen } u}{\cos \frac{\pi}{2} \cos u + \text{sen } \frac{\pi}{2} \text{sen } u}$
 $= \frac{\cos u}{\text{sen } u} = SM$

83. a) $\frac{\sin 3x}{\sin x} - \frac{\cos 3x}{\cos x} = 2$

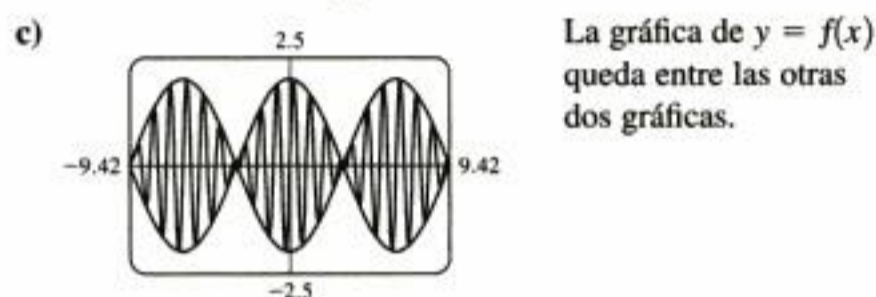
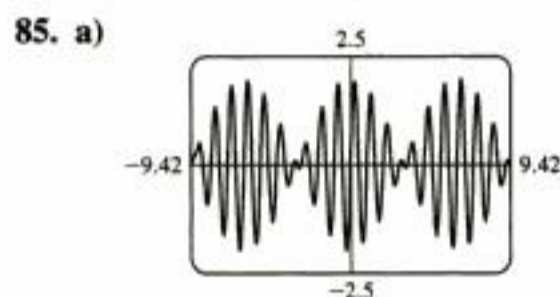
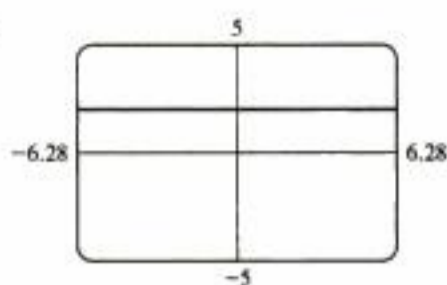

87. a) $P(t) = 8t^4 - 8t^2 + 1$ b) $Q(t) = 16t^5 - 20t^3 + 5t$

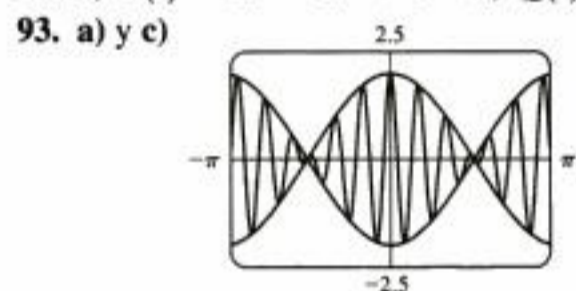

La gráfica de f queda entre las gráficas de $y = 2 \cos t$ y $y = -2 \cos t$. Por lo tanto, la intensidad del sonido varía entre $y = \pm 2 \cos t$.

Sección 7.4 ■ página 557

1. a) $\pi/6$ b) $\pi/3$ c) No está definida
 3. a) $\pi/4$ b) $\pi/4$ c) $-\pi/4$
 5. a) $\pi/2$ b) 0 c) π
 7. a) $\pi/6$ b) $-\pi/6$ c) No está definida
 9. a) 0.13889 b) 2.75876
 11. a) 0.88998 b) No está definida
 13. $\frac{1}{4}$ 15. 5 17. $\pi/3$ 19. $-\pi/6$ 21. $-\pi/3$
 23. $\sqrt{3}/3$ 25. $\frac{1}{2}$ 27. $\pi/3$ 29. $\frac{4}{3}$ 31. $\frac{12}{13}$
 33. $\frac{13}{5}$ 35. $\sqrt{5}/5$ 37. $\frac{24}{25}$ 39. 1 41. $\sqrt{1-x^2}$
 43. $x/\sqrt{1-x^2}$ 45. $\frac{1-x^2}{1+x^2}$ 47. 0

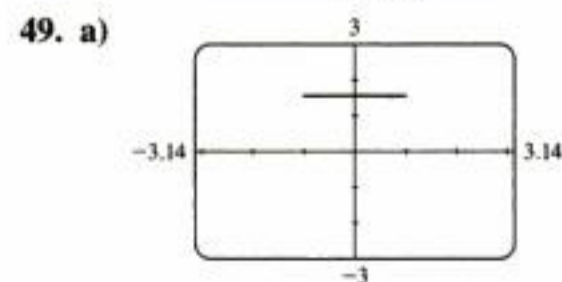

Conjetura : $y = \pi/2$ para $-1 \leq x \leq 1$

51. a) 0.28 b) $(-3 + \sqrt{17})/4$
 53. a) $h = 2 \tan \theta$ b) $\theta = \tan^{-1}(h/2)$
 55. a) $\theta = \sin^{-1}(h/680)$ b) $\theta = 0.826$ rad
 57. a) 54.1° b) $48.3^\circ, 32.2^\circ, 24.5^\circ$. La función \sin^{-1} no está definida para valores fuera del intervalo $[-1, 1]$.

Sección 7.5 ■ página 568

1. $(2k+1)\pi$ 3. $\frac{\pi}{6} + 2k\pi, \frac{5\pi}{6} + 2k\pi$
 5. $\frac{5\pi}{6} + k\pi$ 7. $\frac{\pi}{3} + k\pi, \frac{2\pi}{3} + k\pi$
 9. $\frac{(2k+1)\pi}{4}$ 11. $\frac{\pi}{3} + k\pi, \frac{2\pi}{3} + k\pi$
 13. $\frac{\pi}{2} + k\pi, \frac{7\pi}{6} + 2k\pi, \frac{11\pi}{6} + 2k\pi$
 15. $-\frac{\pi}{3} + k\pi$ 17. $\frac{\pi}{2} + k\pi$ 19. $\frac{\pi}{3} + 2k\pi, \frac{5\pi}{3} + 2k\pi$
 21. $\frac{3\pi}{2} + 2k\pi$ 23. No hay solución
 25. $\frac{7\pi}{18} + \frac{2k\pi}{3}, \frac{11\pi}{18} + \frac{2k\pi}{3}$
 27. $\frac{1}{4}\left(\frac{\pi}{3} + 2k\pi\right), \frac{1}{4}\left(-\frac{\pi}{3} + 2k\pi\right)$
 29. $\frac{1}{2}\left(\frac{\pi}{6} + k\pi\right)$ 31. $4k\pi$ 33. $4\left(\frac{2\pi}{3} + k\pi\right)$
 35. $\frac{k\pi}{3}$ 37. $\frac{\pi}{6} + 2k\pi, \frac{2\pi}{3} + 2k\pi, \frac{5\pi}{6} + 2k\pi, \frac{4\pi}{3} + 2k\pi$
 39. $\frac{\pi}{8} + \frac{k\pi}{2}, \frac{3\pi}{8} + \frac{k\pi}{2}$ 41. $\frac{\pi}{9}, \frac{5\pi}{9}, \frac{7\pi}{9}, \frac{11\pi}{9}, \frac{13\pi}{9}, \frac{17\pi}{9}$
 43. $\frac{\pi}{6}, \frac{3\pi}{4}, \frac{5\pi}{6}, \frac{7\pi}{4}$ 45. $\frac{\pi}{3}, \frac{2\pi}{3}, \frac{4\pi}{3}, \frac{5\pi}{3}$ 47. $0, \frac{2\pi}{3}, \frac{4\pi}{3}$
 49. a) $1.15928 + 2k\pi, 5.12391 + 2k\pi$
 b) 1.15928, 5.12391
 51. a) $1.36944 + 2k\pi, 4.91375 + 2k\pi$
 b) 1.36944, 4.91375
 53. a) $0.46365 + k\pi, 2.67795 + k\pi$
 b) 0.46365, 2.67795, 3.60524, 5.81954
 55. a) $0.33984 + 2k\pi, 2.80176 + 2k\pi$
 b) 0.33984, 2.80176
 57. $((2k+1)\pi, -2)$

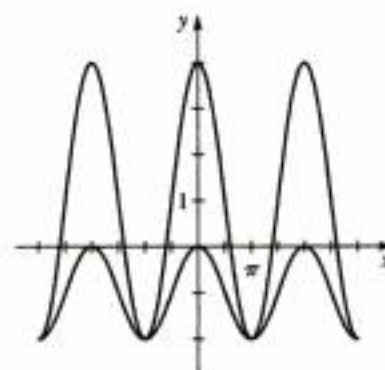

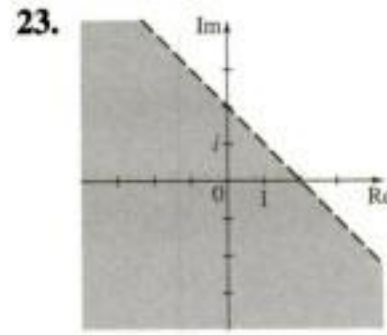
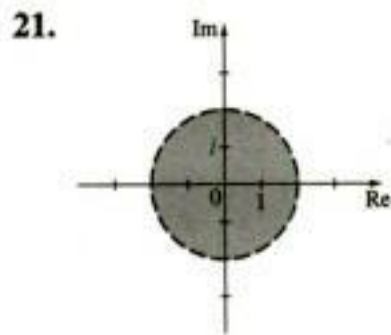
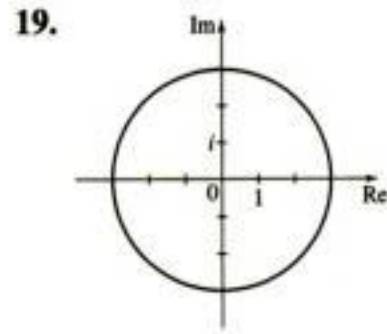
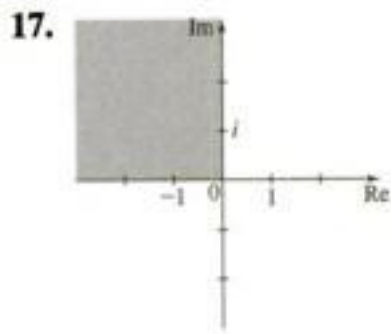

25. $\sqrt{2} \left(\cos \frac{\pi}{4} + i \operatorname{sen} \frac{\pi}{4} \right)$ 27. $2 \left(\cos \frac{7\pi}{4} + i \operatorname{sen} \frac{7\pi}{4} \right)$
 29. $4 \left(\cos \frac{11\pi}{6} + i \operatorname{sen} \frac{11\pi}{6} \right)$ 31. $3 \left(\cos \frac{3\pi}{2} + i \operatorname{sen} \frac{3\pi}{2} \right)$
 33. $5\sqrt{2} \left(\cos \frac{\pi}{4} + i \operatorname{sen} \frac{\pi}{4} \right)$ 35. $8 \left(\cos \frac{11\pi}{6} + i \operatorname{sen} \frac{11\pi}{6} \right)$
 37. $20(\cos \pi + i \operatorname{sen} \pi)$ 39. $5[\cos(\tan^{-1} \frac{4}{3}) + i \operatorname{sen}(\tan^{-1} \frac{4}{3})]$
 41. $3\sqrt{2} \left(\cos \frac{3\pi}{4} + i \operatorname{sen} \frac{3\pi}{4} \right)$ 43. $8 \left(\cos \frac{\pi}{6} + i \operatorname{sen} \frac{\pi}{6} \right)$
 45. $\sqrt{5}[\cos(\tan^{-1} \frac{1}{2}) + i \operatorname{sen}(\tan^{-1} \frac{1}{2})]$
 47. $2 \left(\cos \frac{\pi}{4} + i \operatorname{sen} \frac{\pi}{4} \right)$
 49. $z_1 z_2 = \cos \frac{4\pi}{3} + i \operatorname{sen} \frac{4\pi}{3}$ $\frac{z_1}{z_2} = \cos \frac{2\pi}{3} + i \operatorname{sen} \frac{2\pi}{3}$
 51. $z_1 z_2 = 15 \left(\cos \frac{3\pi}{2} + i \operatorname{sen} \frac{3\pi}{2} \right)$
 $\frac{z_1}{z_2} = \frac{3}{5} \left(\cos \frac{7\pi}{6} - i \operatorname{sen} \frac{7\pi}{6} \right)$
 53. $z_1 z_2 = 8(\cos 150^\circ + i \operatorname{sen} 150^\circ)$
 $z_1/z_2 = 2(\cos 90^\circ + i \operatorname{sen} 90^\circ)$
 55. $z_1 z_2 = 100(\cos 350^\circ + i \operatorname{sen} 350^\circ)$
 $z_1/z_2 = \frac{4}{25}(\cos 50^\circ + i \operatorname{sen} 50^\circ)$
 57. $z_1 = 2 \left(\cos \frac{\pi}{6} + i \operatorname{sen} \frac{\pi}{6} \right)$
 $z_2 = 2 \left(\cos \frac{\pi}{3} + i \operatorname{sen} \frac{\pi}{3} \right)$
 $z_1 z_2 = 4 \left(\cos \frac{\pi}{2} + i \operatorname{sen} \frac{\pi}{2} \right)$
 $\frac{z_1}{z_2} = \cos \frac{\pi}{6} - i \operatorname{sen} \frac{\pi}{6}$
 $\frac{1}{z_1} = \frac{1}{2} \left(\cos \frac{\pi}{6} - i \operatorname{sen} \frac{\pi}{6} \right)$

59. $z_1 = 4 \left(\cos \frac{11\pi}{6} + i \operatorname{sen} \frac{11\pi}{6} \right)$
 $z_2 = \sqrt{2} \left(\cos \frac{3\pi}{4} + i \operatorname{sen} \frac{3\pi}{4} \right)$
 $z_1 z_2 = 4\sqrt{2} \left(\cos \frac{7\pi}{12} + i \operatorname{sen} \frac{7\pi}{12} \right)$
 $\frac{z_1}{z_2} = 2\sqrt{2} \left(\cos \frac{13\pi}{12} + i \operatorname{sen} \frac{13\pi}{12} \right)$
 $\frac{1}{z_1} = \frac{1}{4} \left(\cos \frac{11\pi}{6} - i \operatorname{sen} \frac{11\pi}{6} \right)$
 61. $z_1 = 5\sqrt{2} \left(\cos \frac{\pi}{4} + i \operatorname{sen} \frac{\pi}{4} \right)$
 $z_2 = 4(\cos 0 + i \operatorname{sen} 0)$
 $z_1 z_2 = 20\sqrt{2} \left(\cos \frac{\pi}{4} + i \operatorname{sen} \frac{\pi}{4} \right)$
 $\frac{z_1}{z_2} = \frac{5\sqrt{2}}{4} \left(\cos \frac{\pi}{4} + i \operatorname{sen} \frac{\pi}{4} \right)$
 $\frac{1}{z_1} = \frac{\sqrt{2}}{10} \left(\cos \frac{\pi}{4} - i \operatorname{sen} \frac{\pi}{4} \right)$
 63. $z_1 = 20(\cos \pi + i \operatorname{sen} \pi)$
 $z_2 = 2 \left(\cos \frac{\pi}{6} + i \operatorname{sen} \frac{\pi}{6} \right)$
 $z_1 z_2 = 40 \left(\cos \frac{7\pi}{6} + i \operatorname{sen} \frac{7\pi}{6} \right)$
 $\frac{z_1}{z_2} = 10 \left(\cos \frac{5\pi}{6} + i \operatorname{sen} \frac{5\pi}{6} \right)$
 $\frac{1}{z_1} = \frac{1}{20}(\cos \pi - i \operatorname{sen} \pi)$

65. -1024 67. $512(-\sqrt{3} + i)$ 69. -1 71. 4096
 73. $8(-1 + i)$ 75. $\frac{1}{2048}(-\sqrt{3} - i)$

77. $2\sqrt{2} \left(\cos \frac{\pi}{12} + i \operatorname{sen} \frac{\pi}{12} \right),$
 $2\sqrt{2} \left(\cos \frac{13\pi}{12} + i \operatorname{sen} \frac{13\pi}{12} \right)$

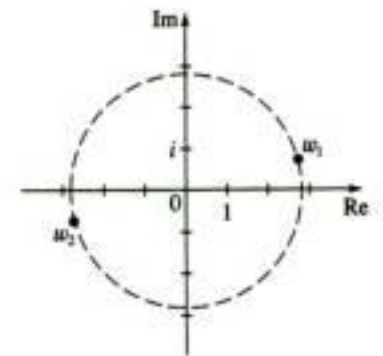

79. $3 \left(\cos \frac{3\pi}{8} + i \operatorname{sen} \frac{3\pi}{8} \right),$
 $3 \left(\cos \frac{7\pi}{8} + i \operatorname{sen} \frac{7\pi}{8} \right),$
 $3 \left(\cos \frac{11\pi}{8} + i \operatorname{sen} \frac{11\pi}{8} \right),$
 $3 \left(\cos \frac{15\pi}{8} + i \operatorname{sen} \frac{15\pi}{8} \right)$

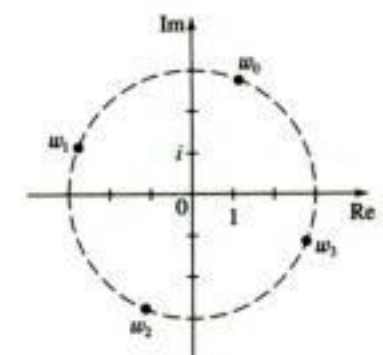

81. $\pm 1, \pm i, \pm \frac{\sqrt{2}}{2} \pm \frac{\sqrt{2}}{2}i$

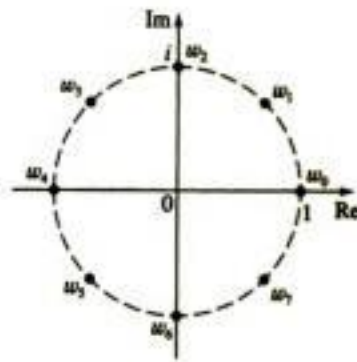

83. $\frac{\sqrt{3}}{2} + \frac{1}{2}i, -\frac{\sqrt{3}}{2} + \frac{1}{2}i, -i$

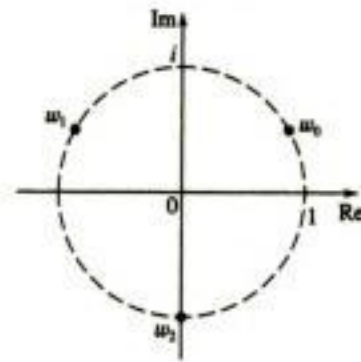

85. $\pm \frac{\sqrt{2}}{2} \pm \frac{\sqrt{2}}{2}i$

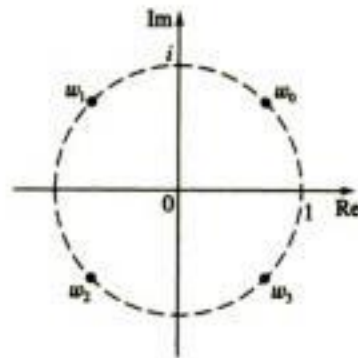

87. $\pm \frac{\sqrt{2}}{2} \pm \frac{\sqrt{2}}{2}i$

89. $2\left(\cos \frac{\pi}{18} + i \operatorname{sen} \frac{\pi}{18}\right), 2\left(\cos \frac{13\pi}{18} + i \operatorname{sen} \frac{13\pi}{18}\right),$
 $2\left(\cos \frac{25\pi}{18} + i \operatorname{sen} \frac{25\pi}{18}\right)$

91. $2^{1/6}\left(\cos \frac{5\pi}{12} + i \operatorname{sen} \frac{5\pi}{12}\right), 2^{1/6}\left(\cos \frac{13\pi}{12} + i \operatorname{sen} \frac{13\pi}{12}\right),$
 $2^{1/6}\left(\cos \frac{21\pi}{12} + i \operatorname{sen} \frac{21\pi}{12}\right)$

Sección 8.4 ■ página 615

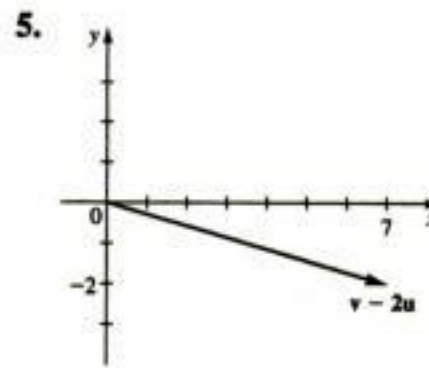
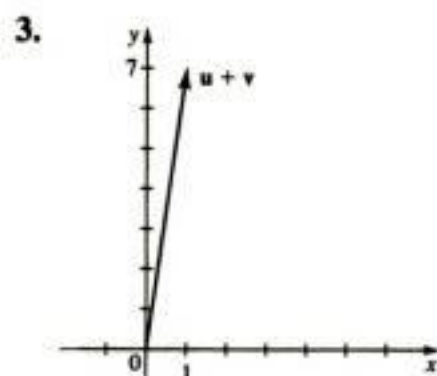
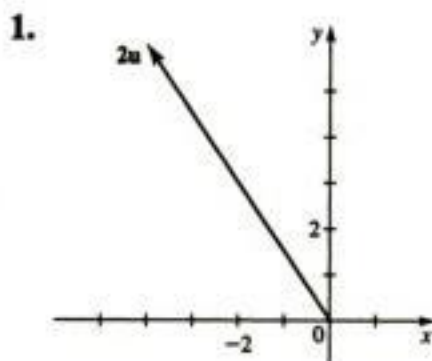

7. (3, 3) 9. (3, -1) 11. (5, 7) 13. (-4, -3)
 15. (0, 2) 17. (4, 14), (-9, -3), (5, 8), (-6, 17)
 19. (0, -2), (6, 0), (-2, -1), (8, -3)
 21. 4i, -9i + 6j, 5i - 2j, -6i + 8j
 23. $\sqrt{5}, \sqrt{13}, 2\sqrt{5}, \frac{1}{2}\sqrt{13}, \sqrt{26}, \sqrt{10}, \sqrt{5} - \sqrt{13}$
 25. $\sqrt{101}, 2\sqrt{2}, 2\sqrt{101}, \sqrt{2}, \sqrt{73}, \sqrt{145}, \sqrt{101} - 2\sqrt{2}$
 27. $20\sqrt{3}i + 20j$ 29. $-\frac{\sqrt{2}}{2}i - \frac{\sqrt{2}}{2}j$
 31. $4 \cos 10^\circ i + 4 \operatorname{sen} 10^\circ j \approx 3.94i + 0.69j$
 33. 5, 53.13° 35. 13, 157.38° 37. 2, 60°
 39. $15\sqrt{3}, -15$ 41. $2i - 3j$
 43. a) 40j b) 425i c) 425i + 40j
 d) 427 millas/h, N 84.6° E 45. 794 millas/h, N 26.6° W
 47. a) 10i b) 10i + 17.32j c) 20i + 17.32j
 d) 26.5 millas/h, N 49.1° E
 49. a) 22.8i + 7.4j b) 7.4 millas/h, 22.8 millas/h
 51. a) (5, -3) b) (-5, 3) 53. a) -4j b) 4j
 55. a) (-7.57, 10.61) b) (7.57, -10.61)
 57. $T_1 \approx -56.5i + 67.4j, T_2 \approx 56.5i + 32.6j$

Sección 8.5 ■ página 624

1. a) 2 b) 45° 3. a) 13 b) 56° 5. a) -1 b) 97°
 7. a) $5\sqrt{3}$ b) 30° 9. Sí 11. No 13. Sí
 15. 9 17. -5 19. $-\frac{12}{5}$ 21. -24
 23. a) (1, 1) b) $u_1 = (1, 1), u_2 = (-3, 3)$
 25. a) $(-\frac{1}{2}, \frac{3}{2})$ b) $u_1 = (-\frac{1}{2}, \frac{3}{2}), u_2 = (\frac{3}{2}, \frac{1}{2})$
 27. a) $(-\frac{18}{5}, \frac{24}{5})$ b) $u_1 = (-\frac{18}{5}, \frac{24}{5}), u_2 = (\frac{28}{5}, \frac{21}{5})$
 29. -28 31. 25 39. 16 pies-lb 41. 8660 pies-lb
 43. 1164 lb 45. 23.6°

Capítulo 8 Repaso ■ página 627

1. a) 3. a)
 b) $(6\sqrt{3}, 6)$ b) $(\frac{-3\sqrt{2}}{2}, \frac{3\sqrt{2}}{2})$
 5. a) b) $(2\sqrt{3}, 6)$

7. a)

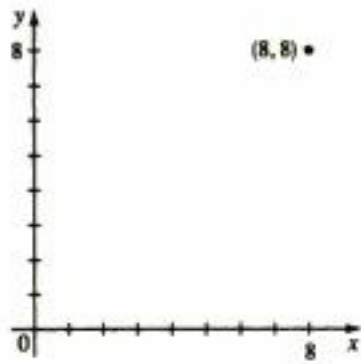

b) $(8\sqrt{2}, \frac{\pi}{4})$

c) $(-8\sqrt{2}, \frac{5\pi}{4})$

11. a)

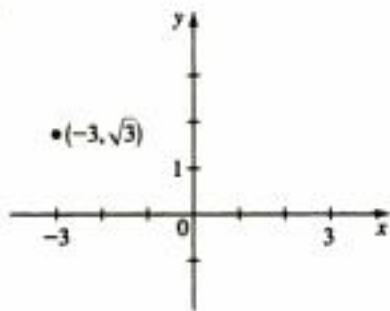

b) $(2\sqrt{3}, \frac{5\pi}{6})$

c) $(-2\sqrt{3}, -\frac{\pi}{6})$

13. a) $r = \frac{4}{\cos \theta + \sin \theta}$

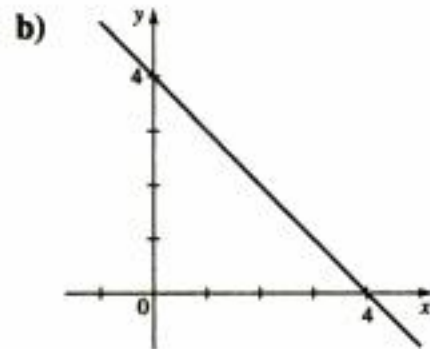

15. a) $r = 4(\cos \theta + \sin \theta)$

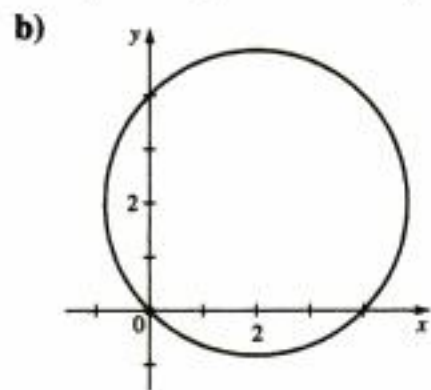

17. a)

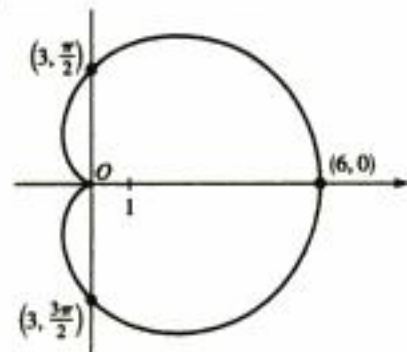

b) $(x^2 + y^2 - 3x)^2 = 9(x^2 + y^2)$

9. a)

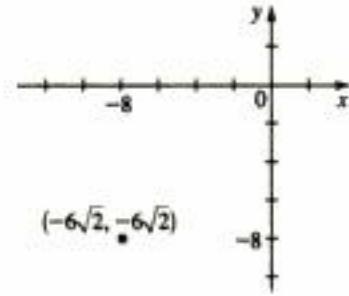

b) $(12, \frac{5\pi}{4})$

c) $(-12, \frac{\pi}{4})$

19. a)

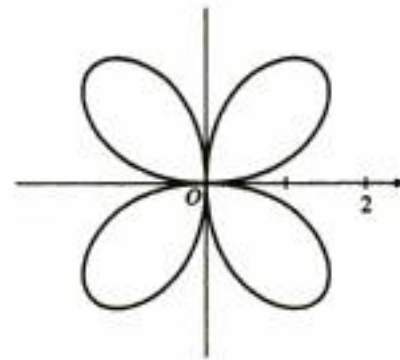

b) $(x^2 + y^2)^3 = 16x^2y^2$

21. a)

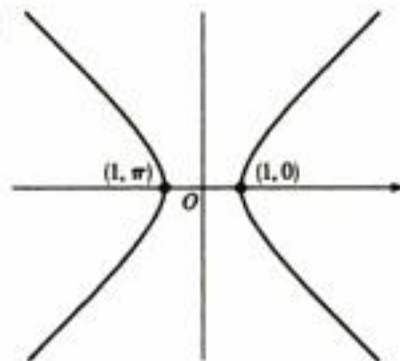

b) $x^2 - y^2 = 1$

23. a)

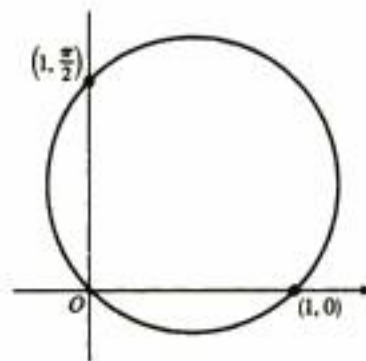

b) $x^2 + y^2 = x + y$

25. $0 \leq \theta \leq 6\pi$

27. $0 \leq \theta \leq 6\pi$

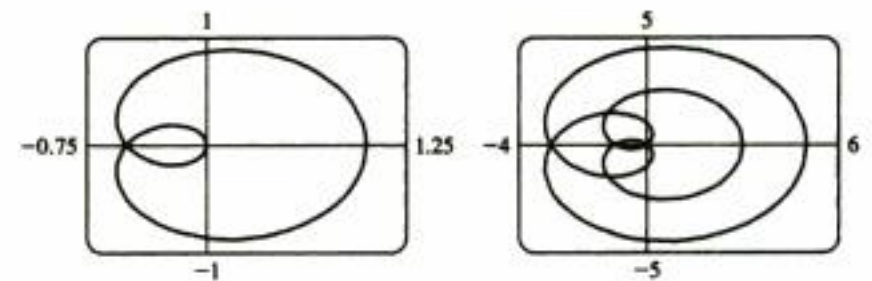

29. a)

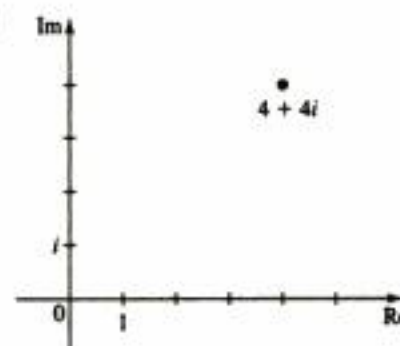

b) $4\sqrt{2}, \frac{\pi}{4}$ c) $4\sqrt{2}(\cos \frac{\pi}{4} + i \sin \frac{\pi}{4})$

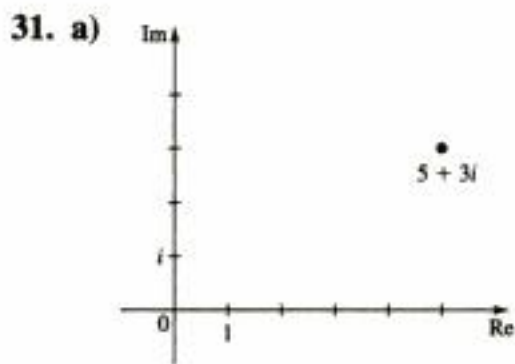

b) $\sqrt{34}, \tan^{-1}(\frac{3}{5})$ c) $\sqrt{34}[\cos(\tan^{-1}(\frac{3}{5})) + i \operatorname{sen}(\tan^{-1}(\frac{3}{5}))]$

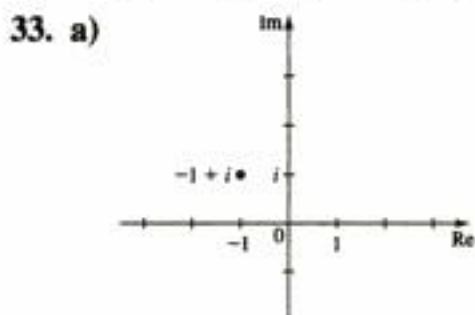

b) $\sqrt{2}, \frac{3\pi}{4}$ c) $\sqrt{2}(\cos \frac{3\pi}{4} + i \operatorname{sen} \frac{3\pi}{4})$

35. $8(-1 + i\sqrt{3})$ 37. $-\frac{1}{32}(1 + i\sqrt{3})$

39. $\pm 2\sqrt{2}(1 - i)$ 41. $\pm 1, \pm \frac{1}{2} \pm \frac{\sqrt{3}}{2}i$

43. $\sqrt{13}, \langle 6, 4 \rangle, \langle -10, 2 \rangle, \langle -4, 6 \rangle, \langle -22, 7 \rangle$

45. $3i - 4j$ 47. $(10, -2)$

49. a) $(4.8i + 0.4j) \times 10^4$ b) 4.8×10^4 lb, N 85.2° E

51. 5, 25, 60 53. $2\sqrt{2}, 8, 0$ 55. Sí 57. No, 45°

59. a) $17\sqrt{37}/37$ b) $(\frac{102}{37}, -\frac{17}{37})$

c) $u_1 = (\frac{102}{37}, -\frac{17}{37}), u_2 = (\frac{9}{37}, \frac{54}{37})$ 61. -6

Capítulo 8 Evaluación ■ página 629

1. a) $(-4\sqrt{2}, -4\sqrt{2})$ b) $(4\sqrt{3}, 5\pi/6), (-4\sqrt{3}, 11\pi/6)$

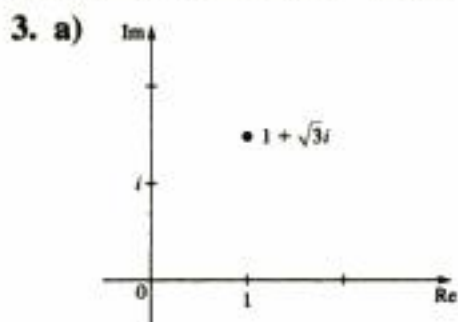

b) $2(\cos \frac{\pi}{3} + i \operatorname{sen} \frac{\pi}{3})$ c) -512

5. $-3i, 3(\pm \frac{\sqrt{3}}{2} + \frac{1}{2}i)$

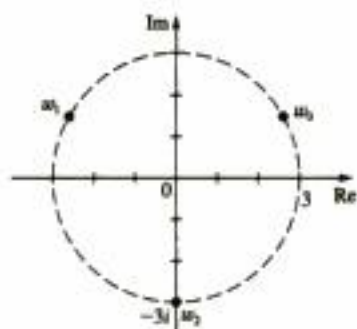

7. a) $\langle 19, -3 \rangle$ b) $5\sqrt{2}$ c) 0 d) Sí

9. a) $14i + 6\sqrt{3}j$ b) 17.4 millas/h, N 53.4° E 11. 90

Enfoque en el modelado ■ página 632

1. a) $R = 18/\pi \approx 5.73$ b) 691.2 millas

3. a) $x \approx -12.23, y \approx 6.27$ b) $x \approx 3.76, y \approx 8.43$

c) $x \approx 15.12, y \approx -3.85$ d) $x \approx -4.31, y \approx -2.42$

5. a) 1.14 b) 1.73 c) 36.81

7. a) 1.48 b) 1.21 c) 1.007

Capítulo 9

Sección 9.1 ■ página 642

1. (3, 1) 3. (4, 16), (-3, 9) 5. (2, -2), (-2, 2)

7. (-25, 5), (-25, -5) 9. (1, 2) 11. (-3, 4), (3, 4)

13. (-2, -1), (-2, 1), (2, -1), (2, 1)

15. $(-1, \sqrt{2}), (-1, -\sqrt{2}), (\frac{1}{2}, \sqrt{\frac{7}{2}}), (\frac{1}{2}, -\sqrt{\frac{7}{2}})$

17. (-2, 3) 19. (2, 4), $(-\frac{5}{2}, \frac{7}{4})$

21. (0, 0), (1, -1), (-2, -4) 23. (4, 0) 25. (-2, -2)

27. (6, 2), (-2, -6) 29. No hay solución

31. $(\sqrt{5}, 2), (\sqrt{5}, -2), (-\sqrt{5}, 2), (-\sqrt{5}, -2)$

33. $(3, -\frac{1}{2}), (-3, -\frac{1}{2})$ 35. $(\frac{1}{5}, \frac{1}{3})$ 37. (-0.33, 5.33)

39. (2.00, 20.00), (-8.00, 0)

41. (-4.51, 2.17), (4.91, -0.97)

43. (1.23, 3.87), (-0.35, -4.21)

45. (-2.30, -0.70), (0.48, -1.19)

47. 12 por 15 cm 49. 15, 20

51. (400.50, 200.25), 447.77 m 53. (12, 8)

Sección 9.2 ■ página 649

1. (2, 2)

3. No hay solución

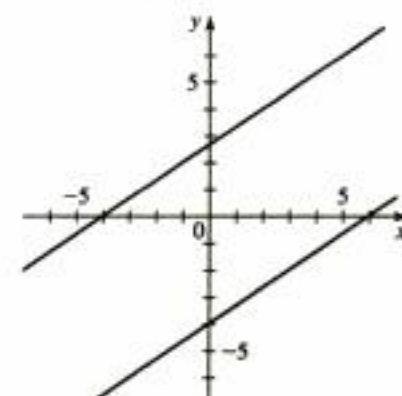
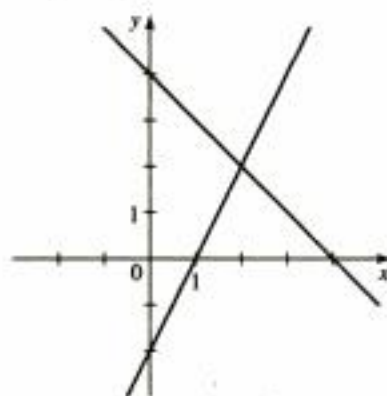

5. Una cantidad infinita de soluciones

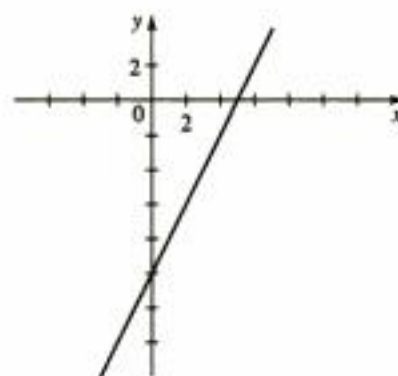

7. (2, 2) 9. (3, -1) 11. (2, 1) 13. (3, 5) 15. (1, 3)

17. (10, -9) 19. No hay solución 21. No hay solución

23. $(x, \frac{1}{3}x - \frac{5}{3})$ 25. $(x, 3 - \frac{3}{2}x)$ 27. $(-3, -7)$
 29. $(x, 5 - \frac{5}{6}x)$ 31. $(5, 10)$ 33. No hay solución
 35. $(3.87, 2.74)$ 37. $(61.00, 20.00)$
 39. $(-\frac{1}{a-1}, \frac{1}{a-1})$ 41. $(\frac{1}{a+b}, \frac{1}{a+b})$ 43. 22, 12
 45. 5 de 10 centavos, 9 de 25 centavos
 47. La velocidad del avión es de 120 millas/h, la velocidad del viento es de 30 millas/h
 49. Corre a 5 millas/h, va en bicicleta a 20 millas/h
 51. 200 g de A, 40 g de B 53. 25%, 10%
 55. \$16 000 al 10%, \$32 000 al 6% 57. 25

Sección 9.3 ■ página 657

1. Lineal 3. No lineal 5. $(1, 3, 2)$
 7. $(4, 0, 3)$ 9. $(5, 2, -\frac{1}{2})$
 11. $\begin{cases} x - 2y - z = 4 \\ -y - 4z = 4 \\ 2x + y + z = 0 \end{cases}$ 13. $\begin{cases} 2x - y + 3z = 2 \\ x + 2y - z = 4 \\ 3y + 7z = 14 \end{cases}$
 15. $(1, 2, 1)$ 17. $(5, 0, 1)$ 19. $(0, 1, 2)$
 21. $(1 - 3t, 2t, t)$ 23. No hay solución
 25. No hay solución 27. $(3 - t, -3 + 2t, t)$
 29. $(2 - 2t, -\frac{2}{3} + \frac{4}{3}t, t)$ 31. $(1, -1, 1, 2)$
 33. 30 000 dólares en bonos de corto plazo, 30 000 dólares en bonos de plazo intermedio, 40 000 dólares en bonos de largo plazo
 35. Imposible
 37. 250 acres de maíz, 500 acres con trigo, 450 acres con soya

Sección 9.4 ■ página 673

1. 3×2 3. 2×1 5. 1×3
 7. a) Sí b) Sí c) $\begin{cases} x = -3 \\ y = 5 \end{cases}$
 9. a) Sí b) No c) $\begin{cases} x + 2y + 8z = 0 \\ y + 3z = 2 \\ 0 = 0 \end{cases}$
 11. a) No b) No c) $\begin{cases} x = 0 \\ 0 = 0 \\ y + 5z = 1 \end{cases}$
 13. a) Sí b) Sí c) $\begin{cases} x + 3y - w = 0 \\ z + 2w = 0 \\ 0 = 1 \\ 0 = 0 \end{cases}$
 15. $(1, 1, 2)$ 17. $(1, 0, 1)$ 19. $(-1, 0, 1)$ 21. $(-1, 5, 0)$
 23. $(10, 3, -2)$ 25. No hay solución 27. $(2 - 3t, 3 - 5t, t)$
 29. No hay solución 31. $(-2t + 5, t - 2, t)$
 33. $x = -\frac{1}{2}s + t + 6, y = s, z = t$ 35. $(-2, 1, 3)$
 37. $(-9, 2, 0)$ 39. $(0, -3, 0, -3)$ 41. $(-1, 0, 0, 1)$

43. $(\frac{7}{4} - \frac{7}{4}t, -\frac{7}{4} + \frac{3}{4}t, \frac{9}{4} + \frac{3}{4}t, t)$
 45. $x = \frac{1}{3}s - \frac{2}{3}t, y = \frac{1}{3}s + \frac{1}{3}t, z = s, w = t$
 47. 2 VitaMax, 1 Vitron, 2 VitaPlus
 49. Correr 5 millas, nadar 2 millas, 30 millas en bicicleta
 51. Imposible

Sección 9.5 ■ página 684

1. No 3. $\begin{bmatrix} 1 & 3 \\ 1 & 5 \end{bmatrix}$ 5. $\begin{bmatrix} 3 & 6 \\ 12 & -3 \\ 3 & 0 \end{bmatrix}$ 7. Imposible
 9. $\begin{bmatrix} 5 & 2 & 1 \\ 7 & 10 & -7 \end{bmatrix}$ 11. $\begin{bmatrix} -1 & -\frac{1}{2} \\ 1 & 2 \end{bmatrix}$
 13. No hay solución 15. $\begin{bmatrix} 0 & -5 \\ -25 & -20 \\ -10 & 10 \end{bmatrix}$
 17. $\begin{bmatrix} 5 & -2 & 5 \\ 1 & 1 & 0 \end{bmatrix}$ 19. $\begin{bmatrix} -1 & -3 & -5 \\ -1 & 3 & -6 \end{bmatrix}$
 21. $\begin{bmatrix} 13 & -\frac{7}{2} & 15 \\ 3 & 1 & 3 \end{bmatrix}$ 23. $\begin{bmatrix} -14 & -8 & -30 \\ -6 & 10 & -24 \end{bmatrix}$
 25. Imposible 27. $\begin{bmatrix} 3 & \frac{1}{2} & 5 \\ 1 & -1 & 3 \end{bmatrix}$ 29. $[28 \ 21 \ 28]$
 31. $\begin{bmatrix} -1 \\ 8 \\ -1 \end{bmatrix}$ 33. $\begin{bmatrix} 8 & -335 \\ 0 & 343 \end{bmatrix}$ 35. Imposible
 37. Imposible 39. $x = 2, y = -1$
 41. $x = 1, y = -2$ 43. $\begin{bmatrix} 2 & -5 \\ 3 & 2 \end{bmatrix} \begin{bmatrix} x \\ y \end{bmatrix} = \begin{bmatrix} 7 \\ 4 \end{bmatrix}$
 45. $\begin{bmatrix} 3 & 2 & -1 & 1 \\ 1 & 0 & -1 & 0 \\ 0 & 3 & 1 & -1 \end{bmatrix} \begin{bmatrix} x_1 \\ x_2 \\ x_3 \\ x_4 \end{bmatrix} = \begin{bmatrix} 0 \\ 5 \\ 4 \end{bmatrix}$
 47. Sólo ACB está definido. $ACB = \begin{bmatrix} -3 & -21 & 27 & -6 \\ -2 & -14 & 18 & -4 \end{bmatrix}$
 49. a) $[4690 \ 1690 \ 13 \ 210]$ b) La ganancia total en Santa Mónica, Long Beach y Anaheim, respectivamente.
 51. a) $[105 \ 000 \ 58 \ 000]$ b) El primer elemento es la cantidad total, en onzas, de la salsa de jitomate producida, y el segundo elemento es la cantidad total, en onzas, de pasta de jitomate producida.
 53. a) $\begin{bmatrix} 1 & 0 & 1 & 0 & 1 & 1 \\ 0 & 3 & 0 & 1 & 2 & 1 \\ 1 & 2 & 0 & 0 & 3 & 0 \\ 1 & 3 & 2 & 3 & 2 & 0 \\ 0 & 3 & 0 & 0 & 2 & 1 \\ 1 & 2 & 0 & 1 & 3 & 1 \end{bmatrix}$

b)
$$\begin{bmatrix} 2 & 1 & 2 & 1 & 2 & 2 \\ 1 & 3 & 1 & 2 & 3 & 2 \\ 2 & 3 & 1 & 1 & 3 & 1 \\ 2 & 3 & 3 & 3 & 3 & 1 \\ 1 & 3 & 1 & 1 & 3 & 2 \\ 2 & 3 & 1 & 2 & 3 & 2 \end{bmatrix}$$

c)
$$\begin{bmatrix} 2 & 3 & 2 & 3 & 2 & 2 \\ 3 & 0 & 3 & 2 & 1 & 2 \\ 2 & 1 & 3 & 3 & 0 & 3 \\ 2 & 0 & 1 & 0 & 1 & 3 \\ 3 & 0 & 3 & 3 & 1 & 2 \\ 2 & 1 & 3 & 2 & 0 & 2 \end{bmatrix}$$

d)
$$\begin{bmatrix} 3 & 3 & 3 & 3 & 3 & 3 \\ 3 & 0 & 3 & 3 & 0 & 3 \\ 3 & 0 & 3 & 3 & 0 & 3 \\ 3 & 0 & 0 & 0 & 0 & 3 \\ 3 & 0 & 3 & 3 & 0 & 3 \\ 3 & 0 & 3 & 3 & 0 & 3 \end{bmatrix}$$



e) La letra E

Sección 9.6 ■ página 697

5. $\begin{bmatrix} 1 & -2 \\ -\frac{3}{2} & \frac{7}{2} \end{bmatrix}$ 7. $\begin{bmatrix} 2 & -3 \\ -3 & 5 \end{bmatrix}$ 9. $\begin{bmatrix} 13 & 5 \\ -5 & -2 \end{bmatrix}$

11. No hay inversa 13. $\begin{bmatrix} 1 & 2 \\ -\frac{1}{2} & \frac{2}{3} \end{bmatrix}$

15. $\begin{bmatrix} -4 & -4 & 5 \\ 1 & 1 & -1 \\ 5 & 4 & -6 \end{bmatrix}$ 17. No hay inversa

19. $\begin{bmatrix} -\frac{9}{2} & -1 & 4 \\ 3 & 1 & -3 \\ \frac{7}{2} & 1 & -3 \end{bmatrix}$ 21. $\begin{bmatrix} 0 & 0 & -2 & 1 \\ -1 & 0 & 1 & 1 \\ 0 & 1 & -1 & 0 \\ 1 & 0 & 0 & -1 \end{bmatrix}$

23. $x = 8, y = -12$ 25. $x = 126, y = -50$
 27. $x = -38, y = 9, z = 47$ 29. $x = -20, y = 10, z = 16$
 31. $x = 3, y = 2, z = 1$ 33. $x = 3, y = -2, z = 2$
 35. $x = 8, y = 1, z = 0, w = 3$

37. $\begin{bmatrix} 7 & 2 & 3 \\ 10 & 3 & 5 \end{bmatrix}$ 39. $\frac{1}{2a} \begin{bmatrix} 1 & 1 \\ -1 & 1 \end{bmatrix}$

41. $\begin{bmatrix} 1 & -\frac{1}{x} \\ -\frac{1}{x} & \frac{2}{x^2} \end{bmatrix}$; no existe inversa para $x = 0$

43. $\frac{1}{2} \begin{bmatrix} 1 & e^{-x} & 0 \\ e^{-x} & -e^{-2x} & 0 \\ 0 & 0 & 1 \end{bmatrix}$; existe la inversa para toda x

45. $\begin{bmatrix} \cos x & -\sin x \\ \sin x & \cos x \end{bmatrix}$; existe la inversa para toda x

47. a) $\begin{bmatrix} 0 & 1 & -1 \\ -2 & \frac{3}{2} & 0 \\ 1 & -\frac{3}{2} & 1 \end{bmatrix}$ b) 1 oz A, 1 oz B, 2 oz C

c) 2 oz A, 0 oz B, 1 oz C d) No

49. a) $\begin{cases} x + y + 2z = 675 \\ 2x + y + z = 600 \\ x + 2y + z = 625 \end{cases}$

b) $\begin{bmatrix} 1 & 1 & 2 \\ 2 & 1 & 1 \\ 1 & 2 & 1 \end{bmatrix} \begin{bmatrix} x \\ y \\ z \end{bmatrix} = \begin{bmatrix} 675 \\ 600 \\ 625 \end{bmatrix}$

c) $A^{-1} = \begin{bmatrix} -\frac{1}{4} & \frac{3}{4} & -\frac{1}{4} \\ -\frac{1}{4} & -\frac{1}{4} & \frac{3}{4} \\ \frac{3}{4} & -\frac{1}{4} & -\frac{1}{4} \end{bmatrix}$

Gana 125 dólares en una enciclopedia estándar, 150 dólares en una de lujo y 200 dólares por una enciclopedia con pasta de piel.

Sección 9.7 ■ página 713

1. 6 3. -4 5. No existe 7. $\frac{1}{8}$ 9. 20, 20 11. -12, 12
 13. 0, 0 15. 4, tiene inversa 17. -6, tiene inversa
 19. 5000, tiene inversa 21. -4, tiene inversa 23. -18
 25. 120 27. a) -2 b) -2 c) Sí 29. (-2, 5)
 31. (0.6, -0.4) 33. (4, -1) 35. (4, 2, -1) 37. (1, 3, 2)
 39. (0, -1, 1) 41. $(\frac{189}{29}, -\frac{108}{29}, \frac{88}{29})$ 43. $(\frac{1}{2}, \frac{1}{4}, \frac{1}{4}, -1)$
 45. abcde 47. 0, 1, 2 49. 1, -1 51. 21 53. $\frac{63}{2}$

57. a) $\begin{cases} 100a + 10b + c = 25 \\ 225a + 15b + c = 33\frac{3}{4} \\ 1600a + 40b + c = 40 \end{cases}$

b) $y = -0.05x^2 + 3x$

Sección 9.8 ■ página 720

1. $\frac{A}{x-1} + \frac{B}{x+2}$ 3. $\frac{A}{x-2} + \frac{B}{(x-2)^2} + \frac{C}{x+4}$

5. $\frac{A}{x-3} + \frac{Bx+C}{x^2+4}$ 7. $\frac{Ax+B}{x^2+1} + \frac{Cx+D}{x^2+2}$

9. $\frac{A}{x} + \frac{B}{2x-5} + \frac{C}{(2x-5)^2} + \frac{D}{(2x-5)^3}$
 $+ \frac{Ex+F}{x^2+2x+5} + \frac{Gx+H}{(x^2+2x+5)^2}$

11. $\frac{1}{x-1} - \frac{1}{x+1}$ 13. $\frac{1}{x-1} - \frac{1}{x+4}$

15. $\frac{2}{x-3} - \frac{2}{x+3}$ 17. $\frac{1}{x-2} - \frac{1}{x+2}$

19. $\frac{3}{x-4} - \frac{2}{x+2}$ 21. $\frac{-\frac{1}{2}}{2x-1} + \frac{\frac{3}{2}}{4x-3}$

23. $\frac{2}{x-2} + \frac{3}{x+2} - \frac{1}{2x-1}$ 25. $\frac{2}{x+1} - \frac{1}{x} + \frac{1}{x^2}$

27. $\frac{1}{2x+3} - \frac{3}{(2x+3)^2}$ 29. $\frac{2}{x} - \frac{1}{x^3} - \frac{2}{x+2}$

39.

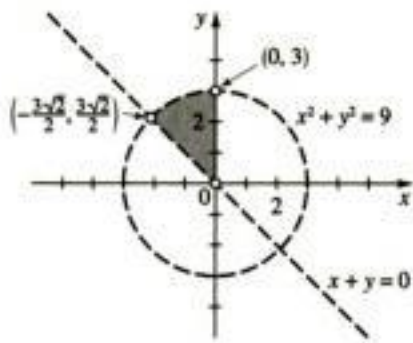

41.

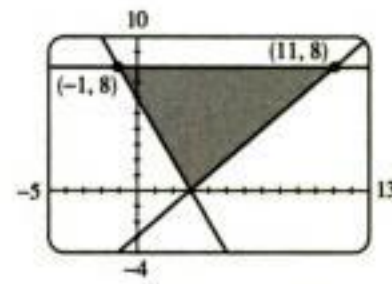

9. No hay solución

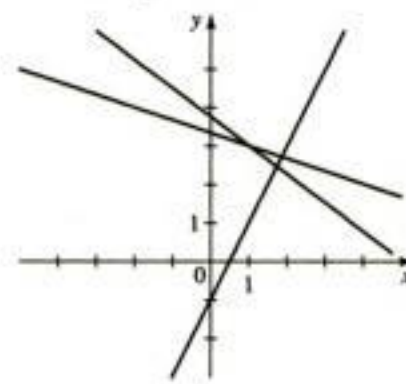

acotada

43.

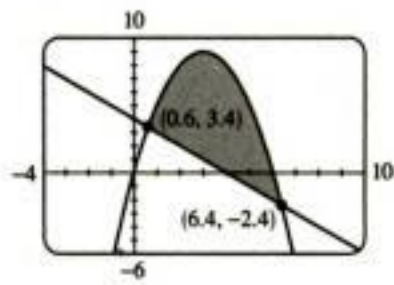

45. x = libros de ficción
 y = libros de no ficción

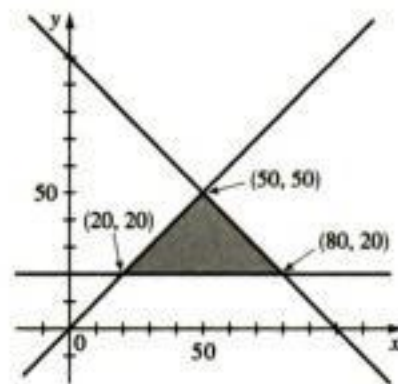
$$\begin{cases} x + y \leq 100 \\ 20 \leq y, x \geq y \\ x \geq 0, y \geq 0 \end{cases}$$

47. x = número de paquetes estándar
 y = número de paquetes de lujo

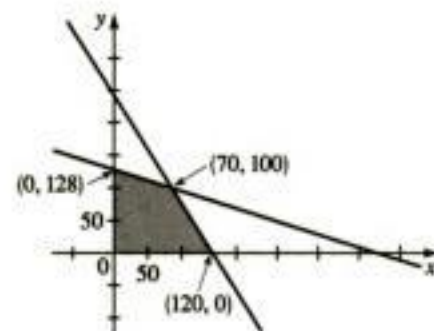
$$\begin{cases} \frac{1}{4}x + \frac{5}{8}y \leq 80 \\ \frac{3}{4}x + \frac{3}{8}y \leq 90 \\ x \geq 0, y \geq 0 \end{cases}$$

Capítulo 9 Repaso ■ página 728

1. (2, 1) 3. $(-\frac{1}{2}, \frac{7}{4}), (2, -2)$
 5. (2, 1)

7. x = cualquier número
 $y = \frac{2}{7}x - 4$

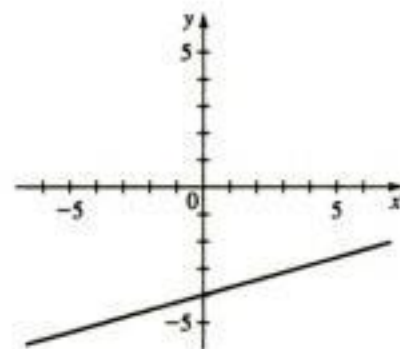
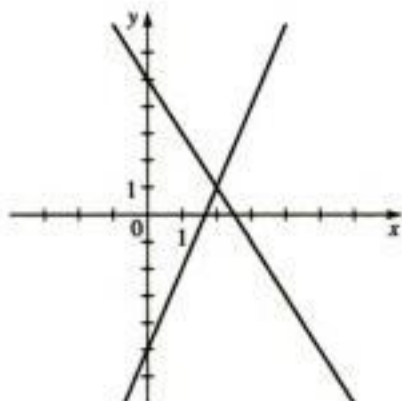

11. (-3, 3), (2, 8) 13. $(\frac{16}{7}, -\frac{14}{3})$

15. (21.41, -15.93) 17. (11.94, -1.39), (12.07, 1.44)

19. a) 2×3 b) Sí c) No

d)
$$\begin{cases} x + 2y = -5 \\ y = 3 \end{cases}$$

21. a) 3×4 b) Sí c) Sí

d)
$$\begin{cases} x + 8z = 0 \\ y + 5z = -1 \\ 0 = 0 \end{cases}$$

23. a) 3×4 b) No c) No

d)
$$\begin{cases} y - 3z = 4 \\ x + y = 7 \\ x + 2y + z = 2 \end{cases}$$

25. (1, 1, 2) 27. No hay solución 29. (-8, -7, 10)

31. No hay solución 33. (1, 0, 1, -2)

35. $x = -4t + 1, y = -t - 1, z = t$

37. $x = 6 - 5t, y = \frac{1}{2}(7 - 3t), z = t$

39. $(-\frac{4}{3}t + \frac{4}{3}, \frac{5}{3}t - \frac{2}{3}, t)$ 41. $(s + 1, 2s - t + 1, s, t)$

43. No hay solución

45. $(1, t + 1, t, 0)$

47. 3000 dólares al 6%, 6000 dólares al 7%

49. 11 250 dólares en el banco A, 22 500 dólares en el banco B, 26 250 dólares en el banco C

51. Imposible

53.
$$\begin{bmatrix} 4 & 18 \\ 4 & 0 \\ 2 & 2 \end{bmatrix}$$

55. $[10 \ 0 \ -5]$ 57. $\begin{bmatrix} -\frac{7}{2} & 10 \\ 1 & -\frac{9}{2} \end{bmatrix}$

59.
$$\begin{bmatrix} 30 & 22 & 2 \\ -9 & 1 & -4 \end{bmatrix}$$

61.
$$\begin{bmatrix} -\frac{1}{2} & \frac{11}{2} \\ \frac{15}{4} & -\frac{3}{2} \\ -\frac{1}{2} & 1 \end{bmatrix}$$

65. $\frac{1}{3} \begin{bmatrix} -1 & -3 \\ -5 & 2 \end{bmatrix}$ 67. $\begin{bmatrix} \frac{7}{2} & -2 \\ 0 & 8 \end{bmatrix}$

69.
$$\begin{bmatrix} 2 & -2 & 6 \\ -4 & 5 & -9 \end{bmatrix}$$

71. $1, \begin{bmatrix} 9 & -4 \\ -2 & 1 \end{bmatrix}$ 73. 0, no hay inversa

75. $-1, \begin{bmatrix} 3 & 2 & -3 \\ 2 & 1 & -2 \\ -8 & -6 & 9 \end{bmatrix}$

77. $24, \begin{bmatrix} 1 & 0 & 0 & -\frac{1}{4} \\ 0 & \frac{1}{2} & 0 & -\frac{1}{4} \\ 0 & 0 & \frac{1}{3} & -\frac{1}{4} \\ 0 & 0 & 0 & \frac{1}{4} \end{bmatrix}$

79. (65, 154) 81. $(-\frac{1}{12}, \frac{1}{12}, \frac{1}{12})$

83. $(\frac{1}{5}, \frac{9}{5})$ 85. $(-\frac{87}{26}, \frac{21}{26}, \frac{3}{2})$

87. 11

89. $\frac{2}{x-5} + \frac{1}{x+3}$

91. $\frac{-4}{x} + \frac{4}{x-1} + \frac{-2}{(x-1)^2}$

93. $\frac{-1}{x} + \frac{x+2}{x^2+1}$

95. $x + y^2 \leq 4$

97.

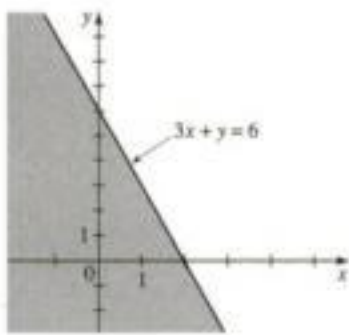

99.

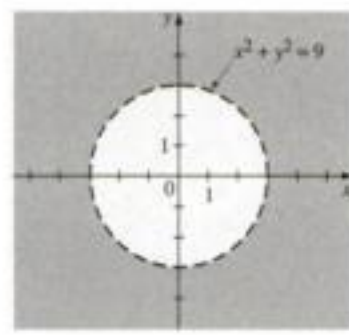

101.

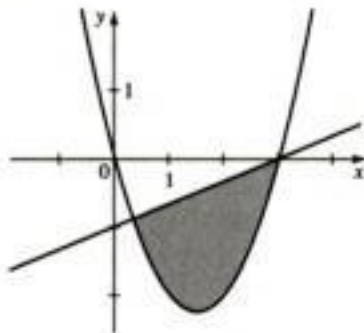

103.

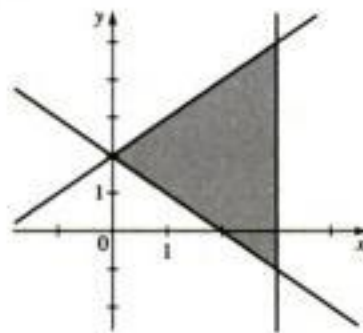

105.

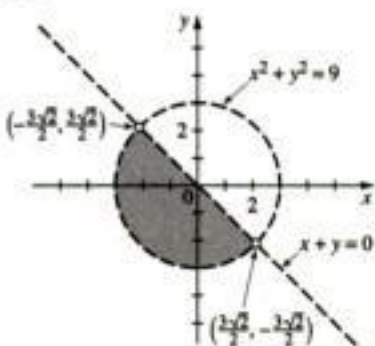

107.

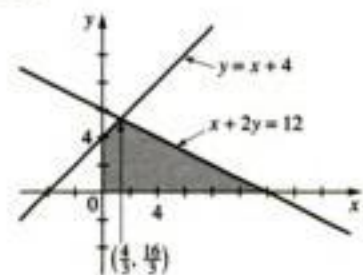

acotada

acotada

109. $x = \frac{b+c}{2}, y = \frac{a+c}{2}, z = \frac{a+b}{2}$

111. 2, 3

Capítulo 9 Evaluación ■ página 733

1. a) Lineal b) (-2, 3)

3. (-0.55, -0.78), (0.43, -0.29), (2.12, 0.56)

5. a) Forma escalonada b) Forma escalonada reducida

c) Ninguna de las dos

7. $(-\frac{3}{5} + \frac{2}{5}t, \frac{1}{5} + \frac{1}{5}t, t)$

9. a) Dimensiones incompatibles

b) Dimensiones incompatibles

c) $\begin{bmatrix} 6 & 10 \\ 3 & -2 \\ -3 & 9 \end{bmatrix}$ d) $\begin{bmatrix} 36 & 58 \\ 0 & -3 \\ 18 & 28 \end{bmatrix}$ e) $\begin{bmatrix} 2 & -\frac{3}{2} \\ -1 & 1 \end{bmatrix}$

f) B no es cuadrada g) B no es cuadrada h) -3

11. $|A| = 0, |B| = 2, B^{-1} = \begin{bmatrix} 1 & -2 & 0 \\ 0 & \frac{1}{2} & 0 \\ 3 & -6 & 1 \end{bmatrix}$

13. a) $\frac{1}{x-1} + \frac{1}{(x-1)^2} - \frac{1}{x+2}$ b) $-\frac{1}{x} + \frac{x+2}{x^2+3}$

Enfoque en el modelado ■ página 739

1. 198, 195

3.

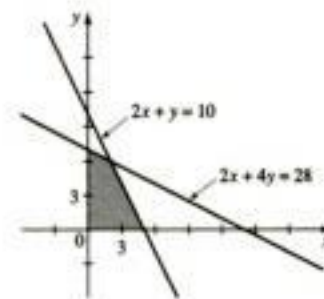

máximo 161

mínimo 135

5. 3 mesas, 34 sillas 7. 30 huacales de toronjas, 30 huacales de naranjas 9. 15 de Pasadena a Santa Mónica, 3 de Pasadena a El Toro, 0 Long Beach a Santa Mónica, 16 de Long Beach a El Toro 11. 90 estándar, 40 de lujo 13. 7500 dólares en bonos municipales, 2500 dólares en certificados bancarios, 2000 dólares en bonos de alto riesgo 15. 4 juegos, 32 educativos, 0 de servicio

Capítulo 10

Sección 10.1 ■ página 751

1. III 3. II 5. VI

Orden de las respuestas: foco; directriz, diámetro focal

7. $F(1, 0); x = -1; 4$

9. $F(0, \frac{9}{4}); y = -\frac{9}{4}; 9$

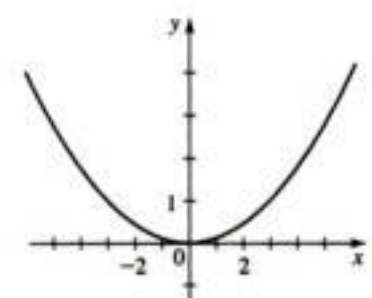
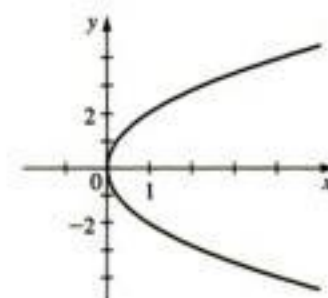

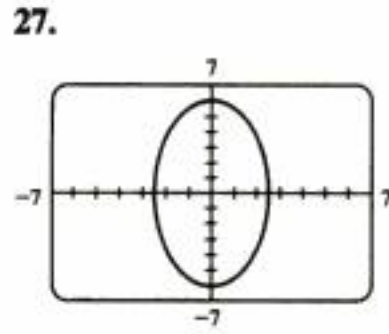
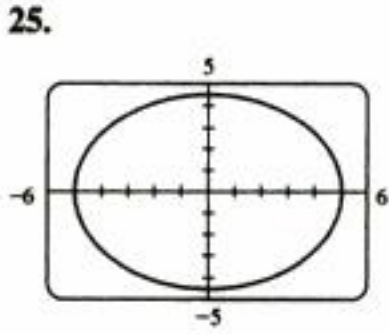

29. $\frac{x^2}{25} + \frac{y^2}{9} = 1$ 31. $x^2 + \frac{y^2}{4} = 1$

33. $\frac{x^2}{9} + \frac{y^2}{13} = 1$ 35. $\frac{x^2}{100} + \frac{y^2}{91} = 1$

37. $\frac{x^2}{25} + \frac{y^2}{5} = 1$ 39. $\frac{64x^2}{225} + \frac{64y^2}{81} = 1$

41. $(0, \pm 2)$

43. $(\pm 1, 0)$

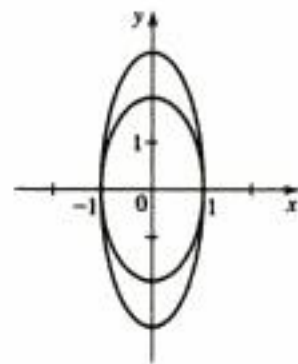
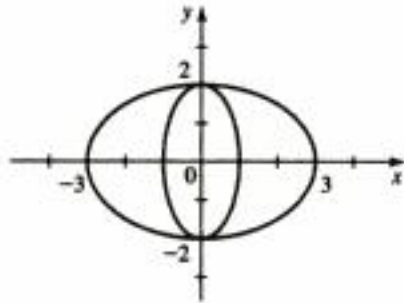

45. a)

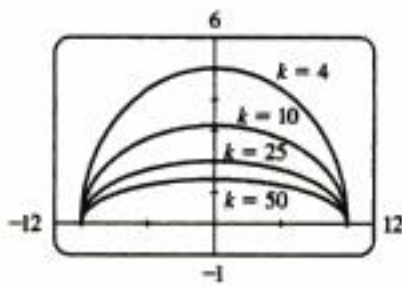

b) Eje mayor y vértices comunes; la excentricidad se incrementa a medida que k aumenta.

47. $\frac{x^2}{2.2500 \times 10^{16}} + \frac{y^2}{2.2491 \times 10^{16}} = 1$

49. $\frac{x^2}{1,455,642} + \frac{y^2}{1,451,610} = 1$ 51. $5\sqrt{39}/2 \approx 15.6$ pulg

Sección 10.3 ■ página 768

1. III 3. II

Orden de las respuestas: vértices; focos; asíntotas

5. $V(\pm 2, 0); F(\pm 2\sqrt{5}, 0); y = \pm 2x$

7. $V(0, \pm 1); F(0, \pm \sqrt{26}); y = \pm \frac{1}{3}x$

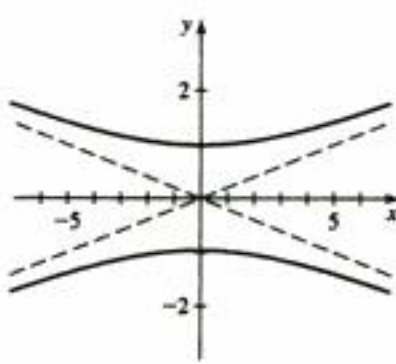
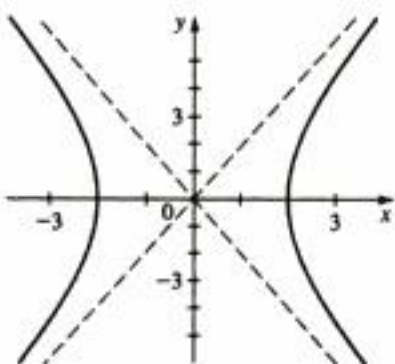

9. $V(\pm 1, 0); F(\pm \sqrt{2}, 0); y = \pm x$

11. $V(0, \pm 3); F(0, \pm \sqrt{34}); y = \pm \frac{3}{5}x$

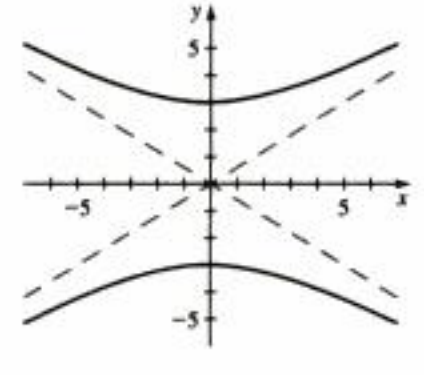
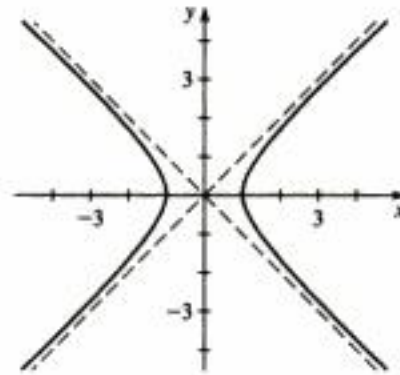

13. $V(\pm 2\sqrt{2}, 0); F(\pm \sqrt{10}, 0); y = \pm \frac{1}{2}x$

15. $V(0, \pm \frac{1}{2}); F(0, \pm \sqrt{5}/2); y = \pm \frac{1}{2}x$

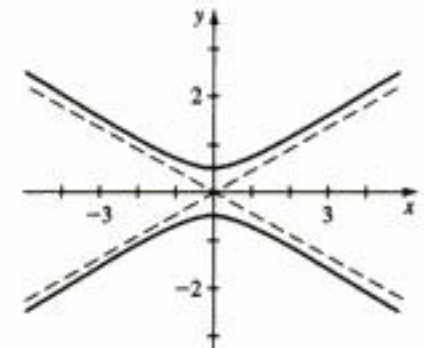
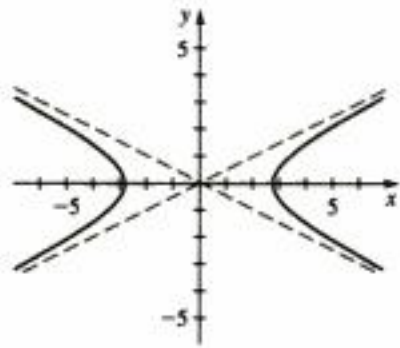

17. $\frac{x^2}{4} - \frac{y^2}{12} = 1$ 19. $\frac{y^2}{16} - \frac{x^2}{16} = 1$ 21. $\frac{x^2}{9} - \frac{4y^2}{9} = 1$

23.

25.

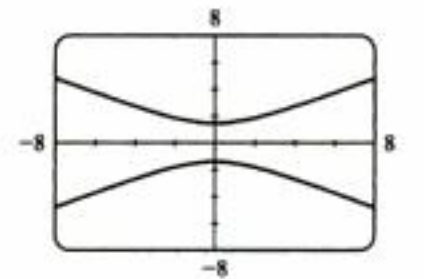
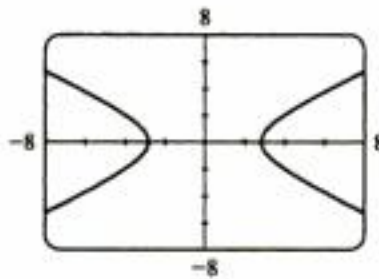

27. $\frac{x^2}{9} - \frac{y^2}{16} = 1$ 29. $y^2 - \frac{x^2}{3} = 1$ 31. $x^2 - \frac{y^2}{25} = 1$

33. $\frac{5y^2}{64} - \frac{5x^2}{256} = 1$ 35. $\frac{x^2}{16} - \frac{y^2}{16} = 1$ 37. $\frac{x^2}{9} - \frac{y^2}{16} = 1$

39. b) $x^2 - y^2 = c^2/2$

43. b)

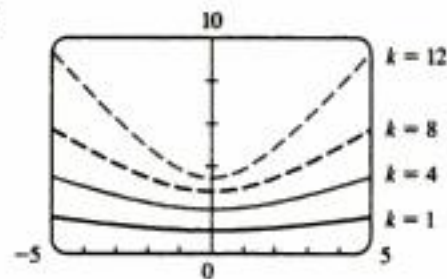

Cuando k aumenta, las asíntotas se vuelven más inclinadas

45. $x^2 - y^2 = 2.3 \times 10^{19}$

Sección 10.4 ■ página 781

1. Centro $C(2, 1)$;
foco $F(2 \pm \sqrt{5}, 1)$;
vértices $V_1(-1, 1), V_2(5, 1)$;
eje mayor 6, eje menor 4

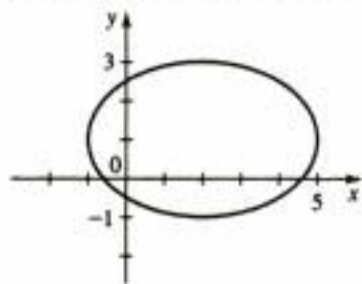

3. Centro $C(0, -5)$;
foco $F_1(0, -1), F_2(0, -9)$;
vértices $V_1(0, 0), V_2(0, -10)$;
eje mayor 10, eje menor 6

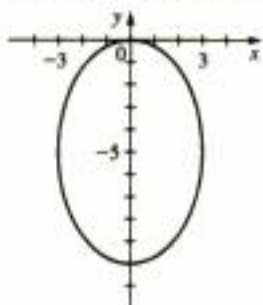

5. Vértice $V(3, -1)$;
foco $F(3, 1)$;
directriz $y = -3$

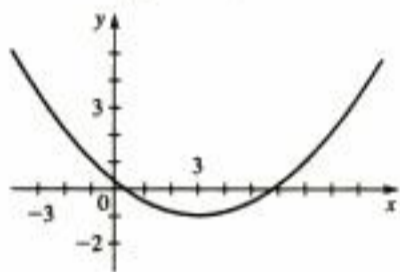

7. Vértice $V(-\frac{1}{2}, 0)$;
foco $F(-\frac{1}{2}, -\frac{1}{16})$;
directriz $y = \frac{1}{16}$

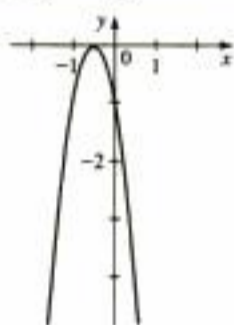

9. Centro $C(-1, 3)$;
foco $F_1(-6, 3), F_2(4, 3)$;
vértices $V_1(-4, 3), V_2(2, 3)$;
asíntotas
 $y = \pm \frac{4}{3}(x + 1) + 3$

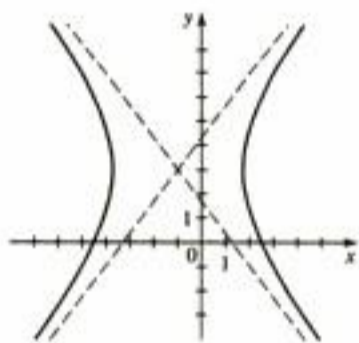

11. Centro $C(-1, 0)$;
foco $F(-1, \pm \sqrt{5})$;
vértices $V(-1, \pm 1)$;
asíntotas
 $y = \pm \frac{1}{2}(x + 1)$

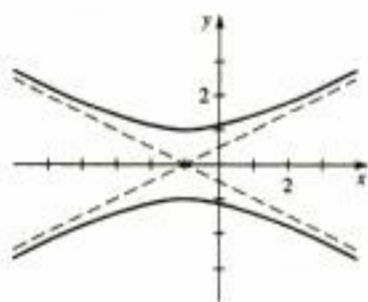

13. $x^2 = -\frac{1}{4}(y - 4)$

15. $\frac{(x - 5)^2}{25} + \frac{y^2}{16} = 1$

17. $(y - 1)^2 - x^2 = 1$

19. Elipse; $C(2, 0)$;
 $F(2, \pm \sqrt{5})$; $V(2, \pm 3)$;
eje mayor 6,
eje menor 4

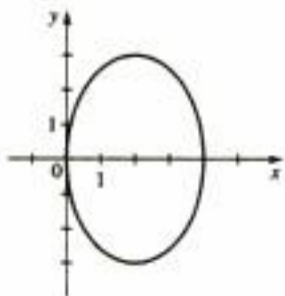

21. Hipérbola;
 $C(1, 2)$; $F_1(-\frac{3}{2}, 2), F_2(\frac{7}{2}, 2)$;
 $V(1 \pm \sqrt{5}, 2)$; asíntotas
 $y = \pm \frac{1}{2}(x - 1) + 2$

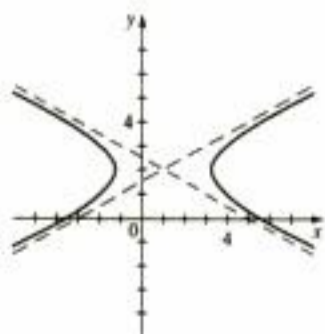

23. Elipse; $C(3, -5)$;
 $F(3 \pm \sqrt{21}, -5)$;
 $V_1(-2, -5), V_2(8, -5)$;
eje mayor 10,
eje menor 4

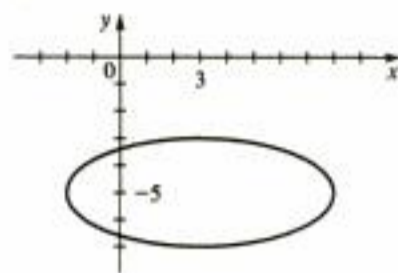

25. Hipérbola; $C(3, 0)$;
 $F(3, \pm 5)$; $V(3, \pm 4)$;
asíntotas $y = \pm \frac{4}{3}(x - 3)$

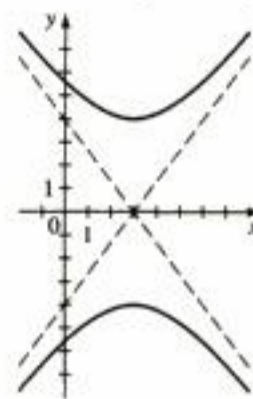

27. Cónica degenerada
(par de rectas),
 $y = \pm \frac{1}{2}(x - 4)$

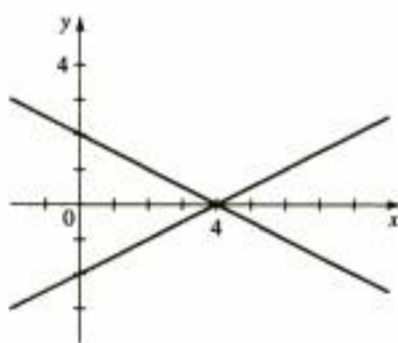

29. Punto $(1, 3)$

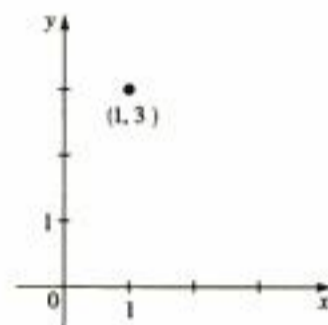

31.

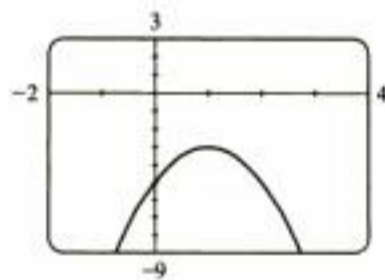

33.

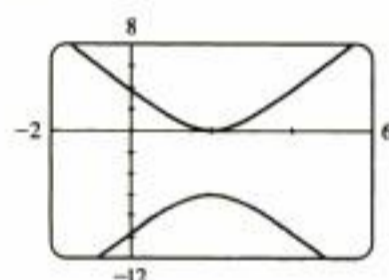

35. a) $F < 17$ b) $F = 17$ c) $F > 17$

37. a)

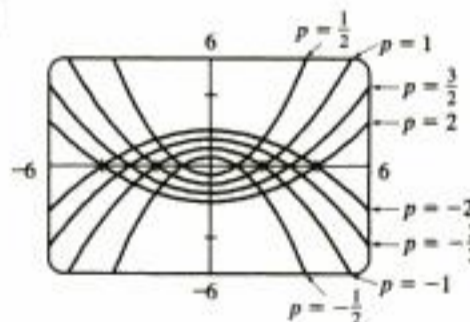

c) Las parábolas se cierran

39. $\frac{(x + 150)^2}{18\,062\,500} + \frac{y^2}{18\,040\,000} = 1$

Sección 10.5 ■ página 790

1. $(\sqrt{2}, 0)$ 3. $(0, -2\sqrt{3})$ 5. $(1.6383, 1.1472)$

7. $X^2 + \sqrt{3}XY + 2 = 0$

9. $7Y^2 - 48XY - 7X^2 - 40X - 30Y = 0$

11. $X^2 - Y^2 = 2$

13. a) Hipérbola b) $X^2 - Y^2 = 16$

c) $\phi = 45^\circ$

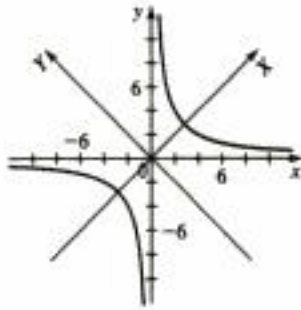

15. a) Parábola

b) $Y = \sqrt{2}X^2$

c) $\phi = 45^\circ$

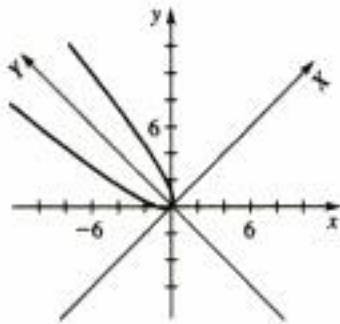

17. a) Hipérbola

b) $Y^2 - X^2 = 1$

c) $\phi = 30^\circ$

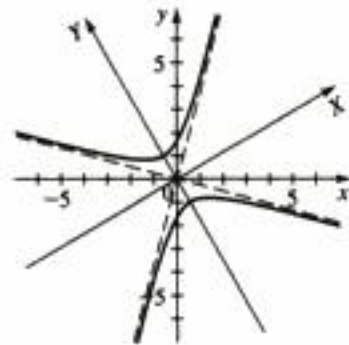

19. a) Hipérbola

b) $\frac{X^2}{4} - Y^2 = 1$

c) $\phi \approx 53^\circ$

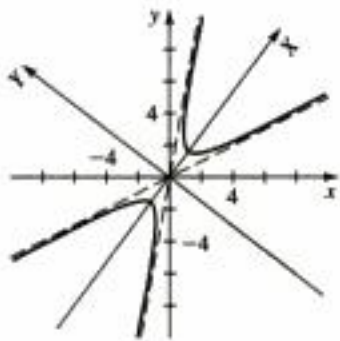

21. a) Hipérbola

b) $3X^2 - Y^2 = 2\sqrt{3}$

c) $\phi = 30^\circ$

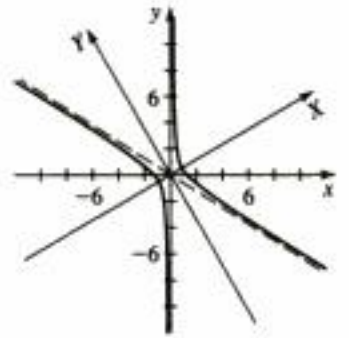

23. a) Hipérbola

b) $(X - 1)^2 - 3Y^2 = 1$

c) $\phi = 60^\circ$

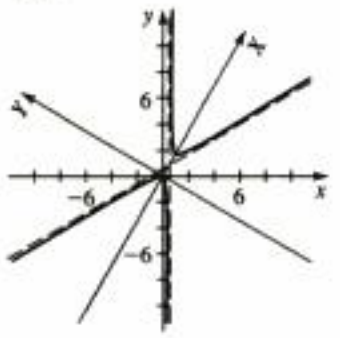

25. a) Elipse

b) $X^2 + \frac{(Y + 1)^2}{4} = 1$

c) $\phi \approx 53^\circ$

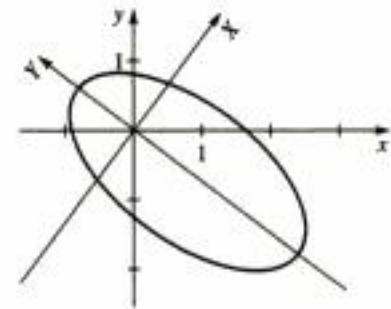

27. a) Parábola

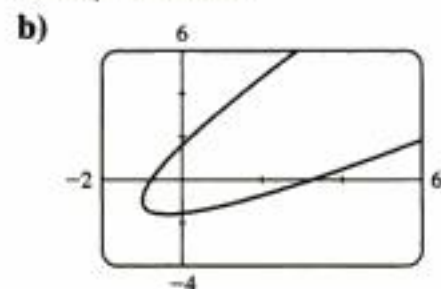

29. a) Hipérbola

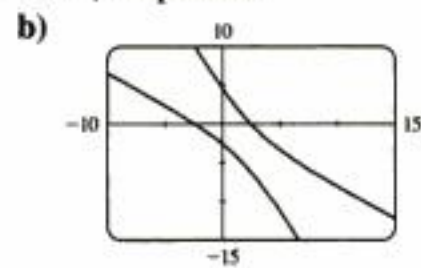

31. a) $(X - 5)^2 - Y^2 = 1$

b) Coordenadas XY:

$C(5, 0); V_1(6, 0), V_2(4, 0); F(5 \pm \sqrt{2}, 0);$

coordenadas xy:

$C(4, 3); V_1(\frac{24}{5}, \frac{18}{5}), V_2(\frac{16}{5}, \frac{12}{5}); F_1(4 + \frac{4}{3}\sqrt{2}, 3 + \frac{4}{3}\sqrt{2}),$

$F_2(4 - \frac{4}{3}\sqrt{2}, 3 - \frac{4}{3}\sqrt{2})$

c) $Y = \pm(X - 5); 7x - y - 25 = 0, x + 7y - 25 = 0$

33. $X = x \cos \phi + y \sin \phi; Y = -x \sin \phi + y \cos \phi$

Sección 10.6 ■ página 799

1. $r = 6/(3 + 2 \cos \theta)$ 3. $r = 2/(1 + \sin \theta)$

5. $r = 20/(1 + 4 \cos \theta)$ 7. $r = 10/(1 + \sin \theta)$

9. II 11. VI 13. IV

15. a) 3, hipérbola

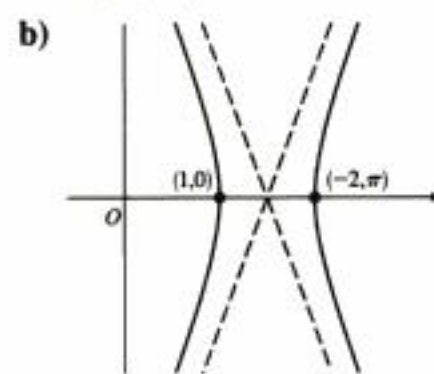

17. a) 1, parábola

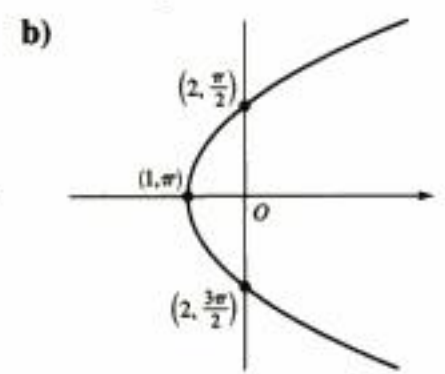

19. a) $\frac{1}{2}$, elipse

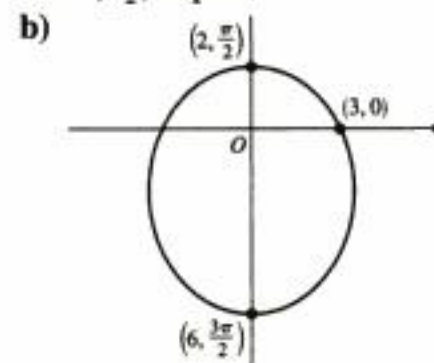

21. a) $\frac{5}{2}$, hipérbola

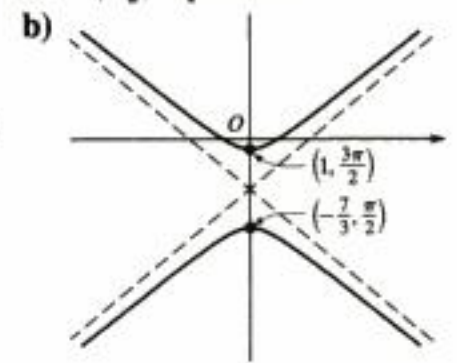

23. a) $e = \frac{3}{4}$, directriz $x = -\frac{1}{3}$

b) $r = \frac{1}{4 - 3 \cos(\theta - \frac{\pi}{3})}$

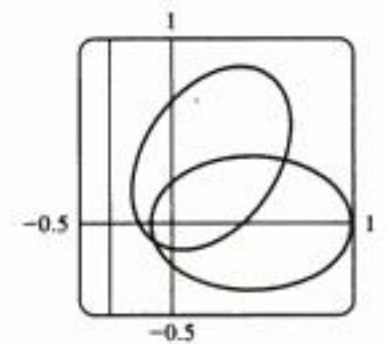

25. La elipse es casi una circunferencia cuando e se acerca a 0 y se vuelve más alargada cuando $e \rightarrow 1^-$. En $e = 1$, la curva se transforma en una parábola.

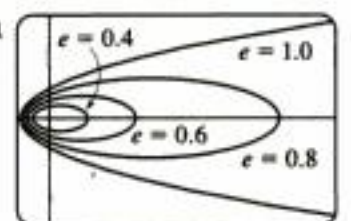

27. b) $r = (1.49 \times 10^8)/(1 - 0.017 \cos \theta)$ 29. 0.25

37. $1 - \sqrt{2}, 1 - \sqrt{3}, -1, 1 - \sqrt{5}; S_n = 1 - \sqrt{n+1}$

39. 10 41. $\frac{11}{6}$ 43. 8 45. 31 47. 385 49. 46438

51. 22 53. $\sqrt{1} + \sqrt{2} + \sqrt{3} + \sqrt{4} + \sqrt{5}$

55. $\sqrt{4} + \sqrt{5} + \sqrt{6} + \sqrt{7} + \sqrt{8} + \sqrt{9} + \sqrt{10}$

57. $x^3 + x^4 + \dots + x^{100}$ 59. $\sum_{k=1}^{100} k$ 61. $\sum_{k=1}^{10} k^2$

63. $\sum_{k=1}^{999} \frac{1}{k(k+1)}$ 65. $\sum_{k=0}^{100} x^k$ 67. $2^{(2^n-1)/2^n}$

69. a) 2004.00, 2008.01, 2012.02, 2016.05, 2020.08, 2024.12

b) \$2149.16

71. a) 35 700, 36 414, 37 142, 37 885, 38 643 b) 42 665

73. b) 6898 75. a) $S_n = S_{n-1} + 2000$ b) \$38 000

Sección 11.2 ■ página 837

1. a) 5, 7, 9, 11, 13 b) 2

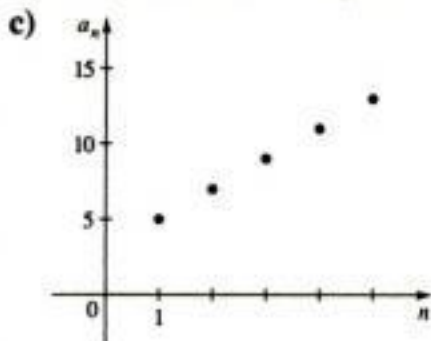

3. a) $\frac{5}{2}, \frac{3}{2}, \frac{1}{2}, -\frac{1}{2}, -\frac{3}{2}$ b) -1

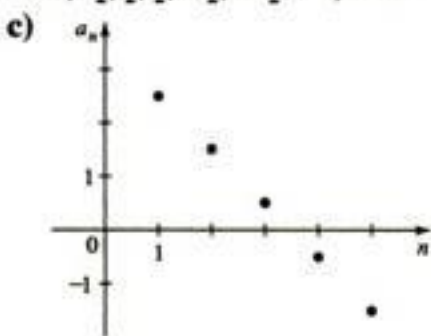

5. $a_n = 3 + 5(n - 1), a_{10} = 48$

7. $a_n = \frac{5}{2} - \frac{1}{2}(n - 1), a_{10} = -2$

9. Aritmética, 3 11. No es aritmética

13. Aritmética, $-\frac{3}{2}$ 15. Aritmética, 1.7

17. 11, 18, 25, 32, 39; 7; $a_n = 11 + 7(n - 1)$

19. $\frac{1}{3}, \frac{1}{5}, \frac{1}{7}, \frac{1}{9}, \frac{1}{11}$; no es aritmética

21. -4, 2, 8, 14, 20; 6; $a_n = -4 + 6(n - 1)$

23. 3, $a_5 = 14, a_n = 2 + 3(n - 1), a_{100} = 299$

25. 5, $a_5 = 24, a_n = 4 + 5(n - 1), a_{100} = 499$

27. 4, $a_5 = 4, a_n = -12 + 4(n - 1), a_{100} = 384$

29. 1.5, $a_5 = 31, a_n = 25 + 1.5(n - 1), a_{100} = 173.5$

31. $s, a_5 = 2 + 4s, a_n = 2 + (n - 1)s, a_{100} = 2 + 99s$

33. $\frac{1}{2}$ 35. -100, -98, -96 37. 30o. 39. 100 41. 460

43. 1090 45. 20 301 47. 832.3 49. 46.75 53. Sí

55. 50 57. \$1250 59. \$403 500 61. 20 63. 78

Sección 11.3 ■ página 844

1. a) 5, 10, 20, 40, 80 b) 2

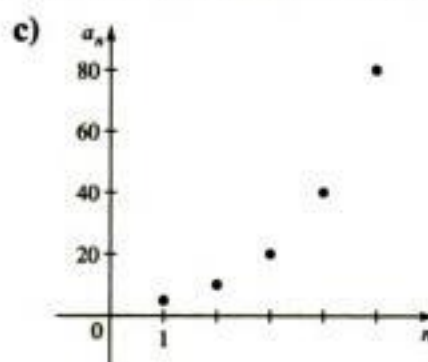

3. a) $\frac{5}{2}, -\frac{5}{4}, \frac{5}{8}, -\frac{5}{16}, \frac{5}{32}$ b) $-\frac{1}{2}$

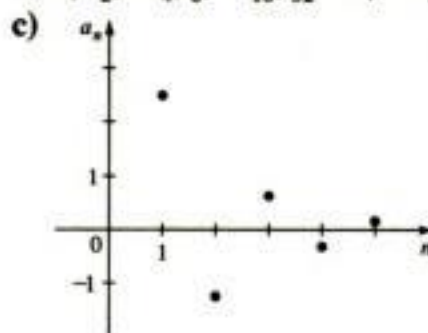

5. $a_n = 3 \cdot 5^{n-1}, a_4 = 375$ 7. $a_n = \frac{5}{2}(-\frac{1}{2})^{n-1}, a_4 = -\frac{5}{16}$

9. Geométrica, 2 11. Geométrica, $\frac{1}{2}$ 13. No es geométrica

15. Geométrica, 1.1 17. 6, 18, 54, 162, 486; geométrica, razón común 3; $a_n = 6 \cdot 3^{n-1}$

19. $\frac{1}{4}, \frac{1}{16}, \frac{1}{64}, \frac{1}{256}, \frac{1}{1024}$; geométrica, razón común $\frac{1}{4}$; $a_n = \frac{1}{4}(\frac{1}{4})^{n-1}$

21. 0, $\ln 5, 2 \ln 5, 3 \ln 5, 4 \ln 5$; no es geométrica

23. 3, $a_5 = 162, a_n = 2 \cdot 3^{n-1}$

25. -0.3, $a_5 = 0.00243, a_n = (0.3)(-0.3)^{n-1}$

27. $-\frac{1}{12}, a_5 = \frac{1}{144}, a_n = 144(-\frac{1}{12})^{n-1}$

29. $3^{2/3}, a_5 = 3^{11/3}, a_n = 3^{(2n+1)/3}$

31. $s^{2/7}, a_5 = s^{8/7}, a_n = s^{2(n-1)/7}$

33. $\frac{1}{2}$ 35. $\frac{25}{4}$ 37. 11o. 39. 315 41. 441 43. 3280

45. $\frac{6141}{1024}$ 47. $\frac{3}{2}$ 49. $\frac{3}{4}$ 51. $\frac{1}{648}$ 53. $-\frac{1000}{117}$ 55. $\frac{7}{9}$

57. $\frac{1}{33}$ 59. $\frac{112}{999}$ 61. 10, 20, 40

63. a) $V_n = 160000(0.80)^{n-1}$ b) Cuarto año

65. 19 pies, $80(\frac{3}{4})^n$ 67. $\frac{64}{25}, \frac{1024}{625}, 5(\frac{4}{3})^n$

69. a) $17\frac{8}{9}$ pies b) $18 - (\frac{1}{3})^{n-3}$ 71. 2801 73. 3 m

75. a) 2 b) $8 + 4\sqrt{2}$ 77. 1

Sección 11.4 ■ página 853

1. \$13 180.79 3. \$360 262.21 5. \$5591.79 7. \$245.66

9. \$2601.59 11. \$307.24 13. \$733.76, \$264 153.60

15. a) \$859.15 b) \$309 294.00 c) \$1 841 519.29

17. \$341.24 19. 18.16% 21. 11.68%

Sección 11.5 ■ página 859

1. Sea $P(n)$ la proposición $2 + 4 + \dots + 2n = n(n + 1)$.

Paso 1 $P(1)$ es verdadera ya que $2 = 1(1 + 1)$.

Paso 2 Suponga que $P(k)$ es verdadera. Entonces

$$\begin{aligned} & 2 + 4 + \cdots + 2k + 2(k + 1) \\ &= k(k + 1) + 2(k + 1) \quad \text{Hipótesis de} \\ & \quad \text{introducción} \\ &= (k + 1)(k + 2) \end{aligned}$$

Por lo que $P(k + 1)$ se infiere de $P(k)$. Por lo tanto, según el Principio de la inducción matemática, $P(n)$ se cumple para toda n .

3. Sea $P(n)$ la proposición

$$5 + 8 + \cdots + (3n + 2) = \frac{n(3n + 7)}{2}.$$

Paso 1 $P(1)$ es verdadera ya que $5 = \frac{1(3 \cdot 1 + 7)}{2}$

Paso 2 Suponga que $P(k)$ es verdadera. Entonces

$$\begin{aligned} & 5 + 8 + \cdots + (3k + 2) + [3(k + 1) + 2] \\ &= \frac{k(3k + 7)}{2} + (3k + 5) \quad \text{Hipótesis de} \\ & \quad \text{inducción} \\ &= \frac{3k^2 + 13k + 10}{2} \\ &= \frac{(k + 1)[3(k + 1) + 7]}{2} \end{aligned}$$

Por lo que $P(k + 1)$ se infiere de $P(k)$. Por lo tanto, según el Principio de la inducción matemática, $P(n)$ se cumple para toda n .

5. Sea $P(n)$ la proposición

$$1 \cdot 2 + 2 \cdot 3 + \cdots + n(n + 1) = \frac{n(n + 1)(n + 2)}{3}.$$

Paso 1 $P(1)$ es verdadera ya que $1 \cdot 2 = \frac{1 \cdot (1 + 1) \cdot (1 + 2)}{3}$.

Paso 2 Suponga que $P(k)$ es verdadera. Entonces

$$\begin{aligned} & 1 \cdot 2 + 2 \cdot 3 + \cdots + k(k + 1) + (k + 1)(k + 2) \\ &= \frac{k(k + 1)(k + 2)}{3} + (k + 1)(k + 2) \quad \text{Hipótesis de} \\ & \quad \text{inducción} \\ &= \frac{(k + 1)(k + 2)(k + 3)}{3} \end{aligned}$$

Por lo que $P(k + 1)$ se infiere de $P(k)$. Por lo tanto, según el Principio de la inducción matemática, $P(n)$ se cumple para toda n .

7. Sea $P(n)$ la proposición

$$1^3 + 2^3 + \cdots + n^3 = \frac{n^2(n + 1)^2}{4}.$$

Paso 1 $P(1)$ es verdadera ya que $1^3 = \frac{1^2 \cdot (1 + 1)^2}{4}$.

Paso 2 Suponga que $P(k)$ es verdadera. Entonces

$$\begin{aligned} & 1^3 + 2^3 + \cdots + k^3 + (k + 1)^3 \\ &= \frac{k^2(k + 1)^2}{4} + (k + 1)^3 \quad \text{Hipótesis de} \\ & \quad \text{inducción} \\ &= \frac{(k + 1)^2[k^2 + 4(k + 1)]}{4} \\ &= \frac{(k + 1)^2(k + 2)^2}{4} \end{aligned}$$

Por lo que $P(k + 1)$ se infiere de $P(k)$. Por lo tanto, según el Principio de la inducción matemática, $P(n)$ se cumple para toda n .

9. Sea $P(n)$ la proposición

$$2^3 + 4^3 + \cdots + (2n)^3 = 2n^2(n + 1)^2.$$

Paso 1 $P(1)$ es verdadera ya que $2^3 = 2 \cdot 1^2(1 + 1)^2$.

Paso 2 Suponga que $P(k)$ es verdadera. Entonces

$$\begin{aligned} & 2^3 + 4^3 + \cdots + (2k)^3 + [2(k + 1)]^3 \\ &= 2k^2(k + 1)^2 + [2(k + 1)]^3 \quad \text{Hipótesis de inducción} \\ &= (k + 1)^2(2k^2 + 8k + 8) \\ &= 2(k + 1)^2(k + 2)^2 \end{aligned}$$

Por lo que $P(k + 1)$ se infiere de $P(k)$. Por lo tanto, según el Principio de la inducción matemática, $P(n)$ se cumple para toda n .

11. Sea $P(n)$ la proposición

$$1 \cdot 2 + 2 \cdot 2^2 + \cdots + n \cdot 2^n = 2[1 + (n - 1)2^n].$$

Paso 1 $P(1)$ es verdadera ya que $1 \cdot 2 = 2[1 + 0]$.

Paso 2 Suponga que $P(k)$ es verdadera. Entonces

$$\begin{aligned} & 1 \cdot 2 + 2 \cdot 2^2 + \cdots + k \cdot 2^k + (k + 1) \cdot 2^{k+1} \\ &= 2[1 + (k - 1)2^k] + (k + 1) \cdot 2^{k+1} \quad \text{Hipótesis de} \\ & \quad \text{inducción} \\ &= 2 + (k - 1)2^{k+1} + (k + 1) \cdot 2^{k+1} \\ &= 2 + 2k2^{k+1} = 2(1 + k2^{k+1}) \end{aligned}$$

Por lo que $P(k + 1)$ se infiere de $P(k)$. Por lo tanto, según el Principio de la inducción matemática, $P(n)$ se cumple para toda n .

13. Sea $P(n)$ la proposición $n^2 + n$ es divisible entre 2.

Paso 1 $P(1)$ es verdadera ya que $1^2 + 1$ es divisible entre 2.

Paso 2 Suponga que $P(k)$ es verdadera. Entonces

$$\begin{aligned} (k + 1)^2 + (k + 1) &= k^2 + 2k + 1 + k + 1 \\ &= (k^2 + k) + 2(k + 1) \end{aligned}$$

Pero $k^2 + k$ es divisible, según la hipótesis de inducción, y $2(k + 1)$ es evidentemente divisible entre 2, de modo que $(k + 1)^2 + (k + 1)$ es divisible entre 2. Entonces $P(k + 1)$ se infiere de $P(k)$. Por lo tanto, según el Principio de la inducción matemática, $P(n)$ se cumple para toda n .

$$\begin{aligned}
 &= \begin{bmatrix} F_{k+1} + F_k & F_{k+1} \\ F_k + F_{k-1} & F_k \end{bmatrix} \\
 &= \begin{bmatrix} F_{k+2} & F_{k+1} \\ F_{k+1} & F_k \end{bmatrix} \quad \text{Definición de la sucesión de Fibonacci}
 \end{aligned}$$

Entonces $P(k + 1)$ se infiere de $P(k)$. Por lo tanto, según el Principio de la inducción matemática, $P(n)$ se cumple para toda $n \geq 2$.

33. Sea $P(n)$ la proposición $F_n \geq n$.

Paso 1 $P(5)$ es verdadera ya que $F_5 \geq 5$ (porque $F_5 = 5$).

Paso 2 Suponga que $P(k)$ es verdadera. Entonces,

$$\begin{aligned}
 F_{k+1} &= F_k + F_{k-1} && \text{Definición de la sucesión de Fibonacci} \\
 &\geq k + F_{k-1} && \text{Hipótesis de inducción} \\
 &\geq k + 1 && \text{Porque } F_{k-1} \geq 1
 \end{aligned}$$

Entonces $P(k + 1)$ se infiere de $P(k)$. Por lo tanto, según el Principio de la inducción matemática, $P(n)$ se cumple para toda $n \geq 5$.

Sección 11.6 ■ página 868

- 1. $x^6 + 6x^5y + 15x^4y^2 + 20x^3y^3 + 15x^2y^4 + 6xy^5 + y^6$
- 3. $x^4 + 4x^2 + 6 + \frac{4}{x^2} + \frac{1}{x^4}$
- 5. $x^5 - 5x^4 + 10x^3 - 10x^2 + 5x - 1$
- 7. $x^{10}y^5 - 5x^8y^4 + 10x^6y^3 - 10x^4y^2 + 5x^2y - 1$
- 9. $8x^3 - 36x^2y + 54xy^2 - 27y^3$
- 11. $\frac{1}{x^5} - \frac{5}{x^{7/2}} + \frac{10}{x^2} + \frac{10}{x^{1/2}} + 5x - x^{5/2}$
- 13. 15 15. 4950 17. 18 19. 32
- 21. $x^4 + 8x^3y + 24x^2y^2 + 32xy^3 + 16y^4$
- 23. $1 + \frac{6}{x} + \frac{15}{x^2} + \frac{20}{x^3} + \frac{15}{x^4} + \frac{6}{x^5} + \frac{1}{x^6}$
- 25. $x^{20} + 40x^{19}y + 760x^{18}y^2$ 27. $25a^{26/3} + a^{25/3}$
- 29. $48,620x^{18}$ 31. $300a^2b^{23}$ 33. $100y^{99}$
- 35. $13,440x^4y^6$ 37. $495a^8b^8$ 39. $(x + y)^4$
- 41. $(2a + b)^3$ 43. $3x^2 + 3xh + h^2$

Capítulo 11 Repaso ■ página 870

- 1. $\frac{1}{2}, \frac{4}{3}, \frac{9}{4}, \frac{16}{5}, \frac{100}{11}$ 3. $0, \frac{1}{4}, 0, \frac{1}{32}, \frac{1}{500}$
- 5. 1, 3, 15, 105; 654 729 075 7. 1, 4, 9, 16, 25, 36, 49
- 9. 1, 3, 5, 11, 21, 43, 85
- 11. a) 7, 9, 11, 13, 15

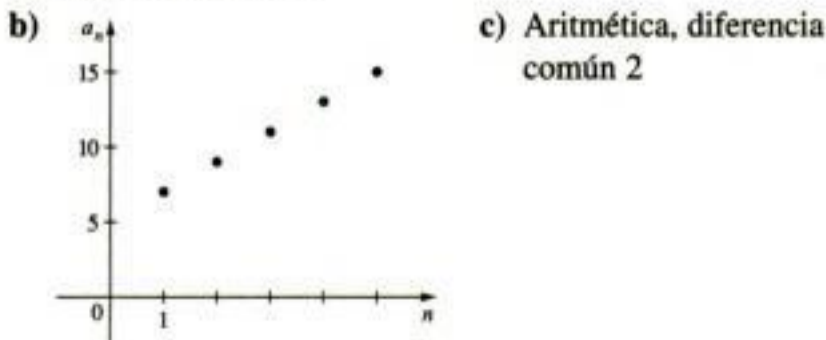

- 13. a) $\frac{3}{4}, \frac{9}{8}, \frac{27}{16}, \frac{81}{32}, \frac{243}{64}$
- b)
- c) Geométrica, razón común $\frac{3}{2}$

- 15. Aritmética, 7 17. Aritmética $5\sqrt{2}$ 19. Aritmética, $t + 1$
- 21. Geométrica, $\frac{4}{27}$ 23. $2i$ 25. 5 27. $\frac{81}{4}$
- 29. a) $A_n = 32\,000(1.05)^{n-1}$
- b) \$32 000, \$33 600, \$35 280, \$37 044, \$38 896.20, \$40 841.01, \$42 883.06, \$45 027.21
- 31. 12 288 35. a) 9 b) $\pm 6\sqrt{2}$
- 37. 126 39. 384
- 41. $0^2 + 1^2 + 2^2 + \dots + 9^2$
- 43. $\frac{3}{2^2} + \frac{3^2}{2^3} + \frac{3^3}{2^4} + \dots + \frac{3^{50}}{2^{51}}$
- 45. $\sum_{k=1}^{33} 3k$ 47. $\sum_{k=1}^{100} k2^{k+2}$
- 49. Geométrica; 4.68559
- 51. Aritmética, $5050\sqrt{5}$
- 53. Geométrica, 9831
- 55. 13 57. 65 534 59. \$2390.27
- 61. $\frac{5}{7}$

63. $\frac{1}{2}(3 + \sqrt{3})$

65. Sea $P(n)$ el enunciado

$$1 + 4 + 7 + \dots + (3n - 2) = \frac{n(3n - 1)}{2}$$

Paso 1 $P(1)$ es verdadero porque $1 = \frac{1(3 \cdot 1 - 1)}{2}$.

Paso 2 Suponga que $P(k)$ es verdadera. Entonces,

$$\begin{aligned}
 &1 + 4 + 7 + \dots + (3k - 2) + [3(k + 1) - 2] \\
 &= \frac{k(3k - 1)}{2} + [3k + 1] \quad \text{Hipótesis de inducción} \\
 &= \frac{3k^2 - k + 6k + 2}{2} \\
 &= \frac{(k + 1)(3k + 2)}{2} \\
 &= \frac{(k + 1)[3(k + 1) - 1]}{2}
 \end{aligned}$$

Entonces $P(k + 1)$ se infiere de $P(k)$. Por lo tanto, según el Principio de la inducción matemática, $P(n)$ se cumple para toda n .

67. Sea $P(n)$ el enunciado

$$(1 + \frac{1}{1})(1 + \frac{1}{2}) \dots (1 + \frac{1}{n}) = n + 1$$

Sección 12.2 ■ página 897

1. a) 5 b) 9 c) 2 d) $-\frac{1}{3}$ e) $-\frac{1}{3}$ f) 0
 g) No existe h) $-\frac{6}{11}$ 3. 75 5. $\frac{1}{2}$ 7. -3
 9. 5 11. 2 13. $\frac{6}{5}$ 15. 12 17. $\frac{1}{6}$ 19. $-\frac{1}{16}$
 21. 4 23. $-\frac{3}{2}$

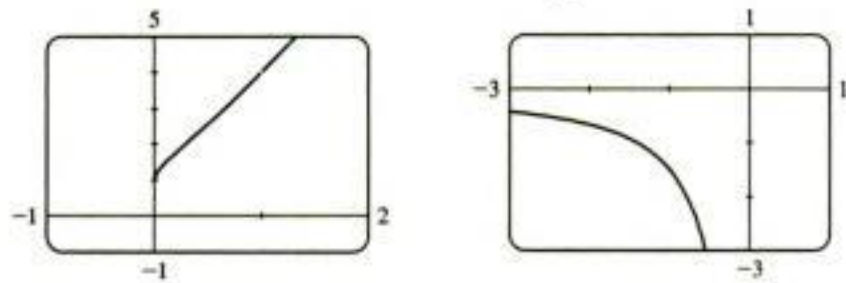

25. a) 0.667

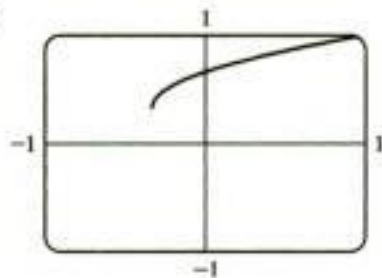

b) 0.667

x	f(x)
0.1	0.71339
0.01	0.67163
0.001	0.66717
0.0001	0.66672

x	f(x)
-0.1	0.61222
-0.01	0.66163
-0.001	0.66617
-0.0001	0.66662

- c) $\frac{2}{3}$
 27. 0 29. No existe 31. No existe
 33. a) 1, 2 b) No existe

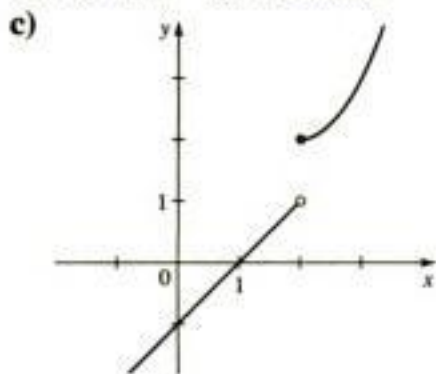

Sección 12.3 ■ página 906

1. 3 3. -11 5. 24
 7. $y = -x - 1$

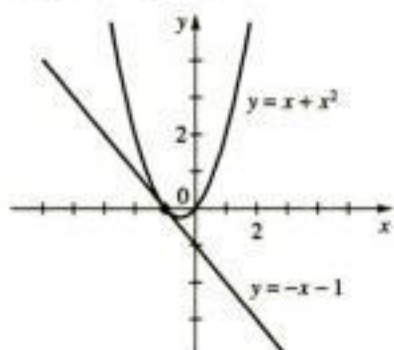

9. $y = -x + 4$

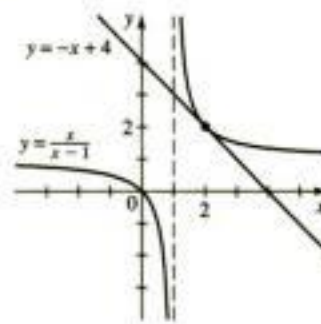

11. $y = \frac{1}{4}x + \frac{7}{4}$

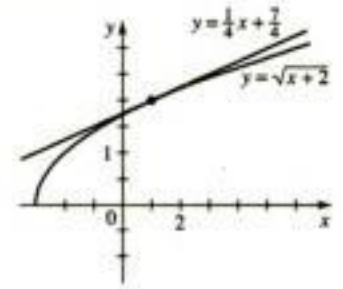

13. $f'(2) = -12$ 15. $g'(1) = 4$ 17. $F'(4) = -\frac{1}{16}$

19. $f'(a) = 2a + 2$ 21. $f'(a) = \frac{1}{(a+1)^2}$

23. a) $f'(a) = 3a^2 - 2$

b) $y = -2x + 4, y = x + 2, y = 10x - 12$

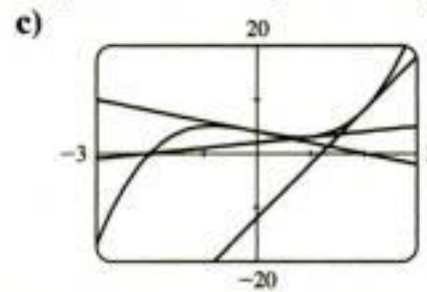

25. -24 pies/s 27. $12a^2 + 6$ m/s, 18 m/s, 54 m/s, 114 m/s

29. $0.75^\circ/\text{min}$ 31. a) -38.3 galones/min, -27.8 galones/min b) -33.3 galones/min

Sección 12.4 ■ página 915

1. a) -1, 2 b) $y = -1, y = 2$ 3. 0 5. $\frac{2}{3}$ 7. $\frac{4}{3}$ 9. 2
 11. No existe 13. 7
 15. $-\frac{1}{4}$ 17. 0 19. 0
 21. Divergente 23. 0 25. Divergente
 27. $\frac{3}{2}$ 29. 8
 31. b) 30 g/L

Sección 12.5 ■ página 924

1. a) 40, 52

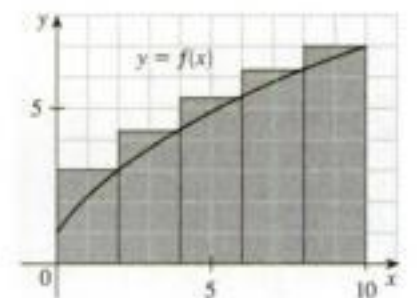
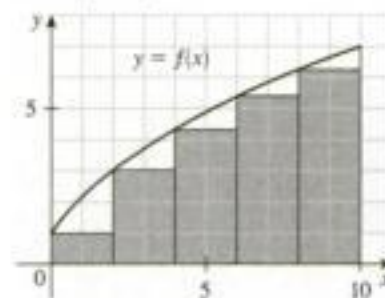

b) 43.2, 49.2

3. 5.25 5. $\frac{223}{35}$

7. a) $\frac{77}{60}$, subestimación

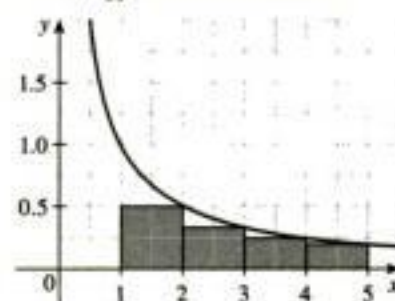

b) $\frac{25}{12}$, sobreestimación

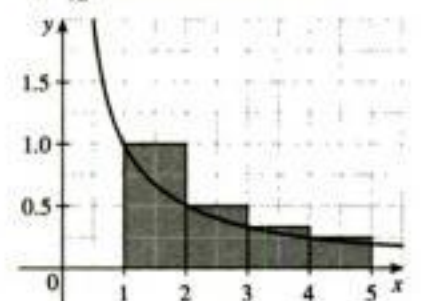

9. a) 8, 6.875

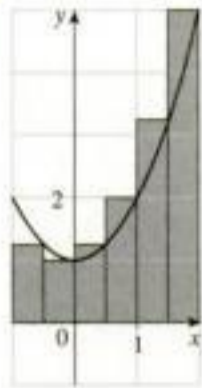

b) 5, 5.375



11. 37.5 13. 8 15. 166.25 17. 133.5

Capítulo 12 Repaso ■ página 925

1. 1 3. 0.69 5. No existe
 7. a) No existe b) 2.4 c) 2.4 d) 2.4 e) 0.5 f) 1
 g) 2 h) 0 9. -3 11. 7 13. 2 15. -1 17. 2
 19. No existe 21. $f'(4) = 3$ 23. $f'(16) = \frac{1}{8}$
 25. a) $f'(a) = -2$ b) -2, -2
 27. a) $f'(a) = 1/(2\sqrt{a+6})$ b) $1/(4\sqrt{2}), 1/4$
 29. $y = 2x + 1$ 31. $y = 2x$ 33. $y = -\frac{1}{4}x + 1$
 35. a) -64 pies/s b) $-32a$ pies/s c) $\sqrt{40} \approx 6.32$ s
 d) -202.4 pies/s 37. $\frac{1}{3}$ 39. $\frac{1}{2}$ 41. Divergente
 43. 3.83 45. 10 47. $\frac{5}{6}$

Capítulo 12 Evaluación ■ página 928

1. a) $\frac{1}{2}$ b)

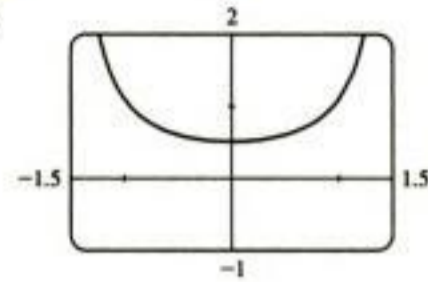

3. a) 6 b) -2 c) No existe d) No existe e) $\frac{1}{4}$ f) 2
 5. $y = \frac{1}{6}x + \frac{3}{2}$ 7. a) $\frac{89}{25}$ b) $\frac{11}{3}$

Enfoque en el modelado ■ página 931

1. $57333\frac{1}{3}$ pies-lb 3. b) Área bajo la gráfica de $p(x) = 375x$ entre $x = 0$ y $x = 4$ c) 3000 lb d) 1500 lb
 5. a) 1625.28 grados de calentamiento hora b) 70°F
 c) 1488 grados de calentamiento horas d) 75°F
 e) El día en el inciso a)